

44 W SELV Dimmable DALI-2 LED driver

Product code: 5957

44 W 220 – 240 V 0/ 50 – 60 Hz

- DALI-2 certified LED driver, 1-100 % dimming range
- SELV output protection for safety and flexibility in luminaires
- Amplitude dimming for the highest quality light output, complying with IEEE 1789 recommendation
- Suitable for DC use
- Optimised driver mechanics for independent usage applications
- Integrated spacious strain reliefs with screwless clamps, quick and simple installation process
- Doubled input terminals for looping the mains and DALI cables
- Ideal solution for Class I, Class II and Class III (SELV) luminaires



Functional Description

- Adjustable constant current output: 500 mA to 1000 mA (default)
- Suitable for flicker-free camera recording applications
- Full load recognition, open and short circuit protection
- Push to Fade functionality for easy-to-use intensity control with smooth fade in transitions

Mains Characteristics

Voltage range	198 VAC – 264 VAC
	Withstands max. 300 VAC (max. 1 hour)
DC range	176 VDC - 280 VDC
starting voltage	> 190 VDC
Mains current at full load	0.20 – 0.27 A
Frequency	0 / 50 Hz – 60 Hz
Stand-by power consumption	< 0.5 W
THD at full power	< 10 %
Tested surge protection	1 kV L-N, 2 kV L-GND (IEC 61000-4-5)
Tested fast transient protection	1 kV (IEC 61000-4-4)

Insulation between circuits & driver case

Mains circuit - SELV circuit	Double/reinforced insulation
DALI circuit - SELV circuit	Double/reinforced insulation
Mains circuit - DALI circuit	Basic insulation
Mains, DALI and output - Driver case	Double/reinforced insulation

Load Output (SELV <60 V)

Output current (I_{out})	500 mA – 1000 mA (default)
Accuracy	± 5 %
Ripple	< 3 %* at ≤ 120 Hz *) Low frequency, LED load: Cree XP-G LEDs
PstLM	< 0.03*
SVM	< 0.01* *) At full power, measured with Cree XP-G LED modules.
U_{out} (max) (abnormal)	60 V

I_{LED}	500 mA	750 mA	1000 mA
P_{Rated}	22 W	33 W	44 W
U_{LED}	24 - 44 V	24 - 44 V	24 - 44 V
PF (λ) at full load	0.96	0.98	0.99
Efficiency (η) at full load	89 %	89 %	89 %

Operating window

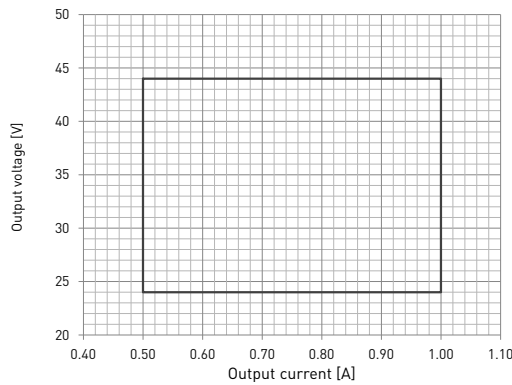

Current THD

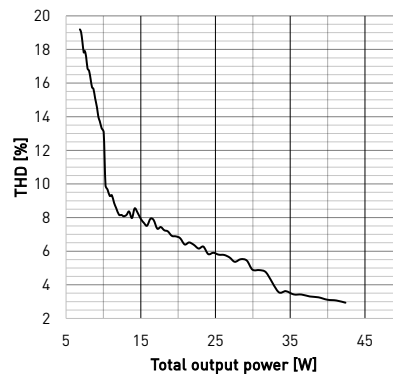

Note: Dimming between 1% - 100% possible across the whole operating window

Driver performance

Typical efficiency

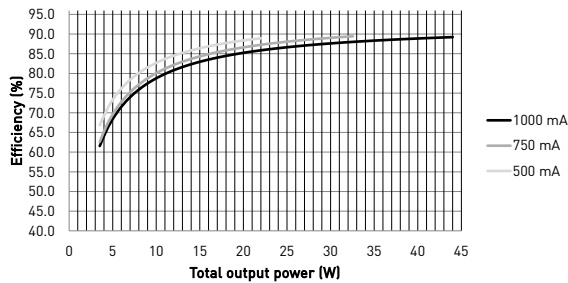

Typical power factor

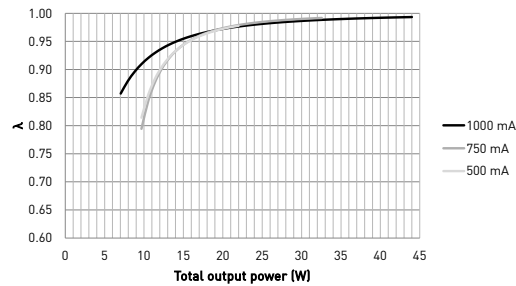

Operating Conditions and Characteristics

Absolute highest allowed t_c point temperature	75 °C
T_c life (50 000 h) temperature	75 °C
Ambient temperature range	-20 °C ... +50 °C*
in independent use	-20 °C ... +50 °C
Storage temperature range	-25 °C ... +60 °C
Maximum relative humidity	No condensation
Life time (90 % survival rate)	50 000 h, at $t_c = 75$ °C 100 000 h at $t_c = 65$ °C

*) For other than independent use, higher t_a of the controlgear possible as long as highest allowed t_c point temperature is not exceeded

Quantity of drivers per miniature circuit breaker 16 A Type C

Based on inrush current I_{peak}	Typ. peak inrush current I_{peak}	1/2 value time, Δt	Calculated energy, $I_{peak}^2 \Delta t$
850*	6.4 A	45 μ s	0.600 mA ² s

*Inrush current is not the limiting factor for the products per MCB, please notice the continuous current limitations.

CONVERSION TABLE FOR OTHER TYPES OF MINIATURE CIRCUIT BREAKER

MCB type	Relative quantity of LED drivers
B 10 A	37 %
B 16 A	60 %
B 20 A	75 %
C 10 A	62 %
C 16 A	100 % [see table above]
C 20 A	125 %

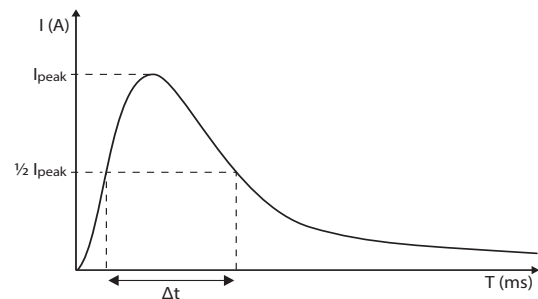

CONTINUOUS CURRENT

Total continuous current of the drivers and installation environment must always be considered and taken into calculations when installing drivers behind miniature circuit breaker. Example calculation of total drivers amount limited by continuous current: $n(I_{cont}) = [16 A (I_{nom, T_a}) / \text{"nominal mains current with full load"}] \times 0.76$. This calculation is an example according to recommended precautions due to multiple adjacent circuit breakers (> 9 MCBs) and installation environment (T_a 30 degrees); variables may vary according to the use case. Both inrush current and continuous current calculations are based on ABB S200 series circuit breakers. More specific information in ABB series S200 circuit breaker documentation.

NOTE! Type C MCB's are strongly recommended to use with LED lighting. Please see more details in "MCB information" document in each driver product page in "downloads & links" section.

Amplitude dimming technology

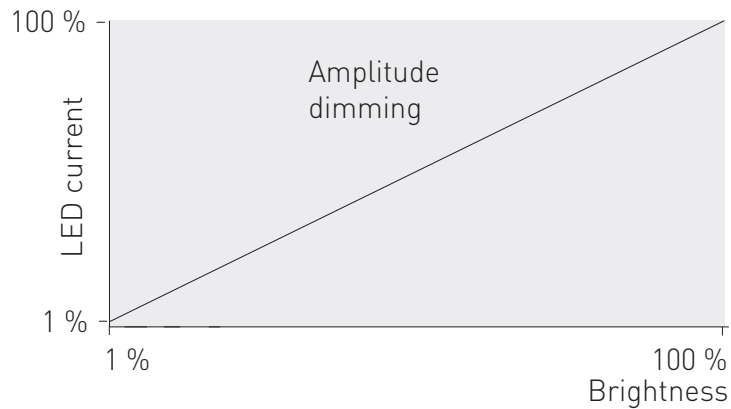

Dimming range	Dimming technology
1 % – 100 %	Amplitude (DC)

LC44SEC-DA-500-1000-LOOP LED driver implements amplitude dimming technology across whole dimming range. Amplitude dimming offers the best available technology for dimming the light output in an accurate and flicker-free way to ensure high quality lighting in even the most demanding situations such as camera recording applications. Amplitude dimming technology complies with IEEE 1789-2015 recommendations of current modulation to mitigate health risks to viewers.

In LC44SEC-DA-500-1000-LOOP, the current can be set with DIP switches. With each combination of switch setup, a different output current value can be set. The maximum value can be reached with all switches set to "1" and minimum with all switches set to "0". The output current values according to the DIP switch settings are presented below.

Setting Current via DIP Switch

DIP switch combination	1111	0111	1011	0011	1101	0101	1001	0001
I_{out} (mA)	1000	950	900	850	800	750	700	650
Voltage range	24 - 44 V	24 - 44 V	24 - 44 V	24 - 44 V	24 - 44 V	24 - 44 V	24 - 44 V	24 - 44 V
DIP switch combination	1110	0110	1010	0010	1100	0100	1000	0000
I_{out} (mA)	600	550	500	500	500	500	500	500
Voltage range	24 - 44 V	24 - 44 V	24 - 44 V	24 - 44 V	24 - 44 V	24 - 44 V	24 - 44 V	24 - 44 V

Connections and Mechanical Data

Wire size	Input: 0.5 mm ² – 2.5 mm ²
	Output: 0.5 mm ² – 1.5 mm ²
Wire type	Solid core and fine-stranded
Wire insulation	According to EN 60598
Maximum current through looping terminals	16 A
Maximum driver to LED wire length	1.5 m
Weight	209 g
IP rating	IP20

Connections

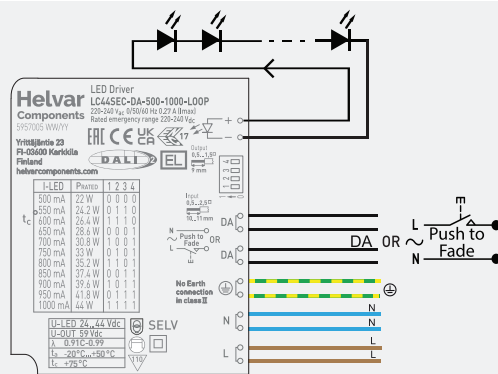

Note:

- PE terminal is for looping only and therefore earth connection is not needed for the functionality of the driver. See page 5 for details.
- When looping mains, only additional LED drivers shall be connected through the device terminals
- Not suitable for load side switching operation
- Label may differ if the unit is preset to fixed current

Dimensions (mm)

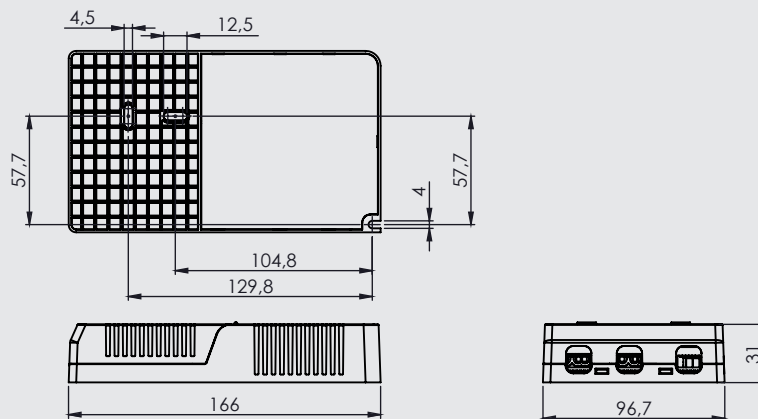

LC44SEC-DA-500-1000-LOOP LED driver is suited for independent use and built-in usage in luminaires. In order to have safe and reliable LED driver operation, the LED luminaires will need to comply with the relevant standards and regulations (e.g. IEC/EN 60598-1). The LED luminaire shall be designed to adequately protect the LED driver from dust, moisture and pollution. The luminaire is not allowed to be covered with thermally insulating material. The luminaire manufacturer is responsible for the correct choice and installation of the LED drivers according to the application and product datasheets. Operating conditions of the LED drivers may never exceed the specifications as per the product datasheet.

Installation & operation

Maximum ambient and t_c temperature:

- For built-in components inside luminaires, the t_a ambient temperature range is a guideline given for the optimum operating environment. However, integrator must always ensure proper thermal management (i.e. mounting base of the driver, air flow etc.) so that the t_c point temperature does not exceed the t_c maximum limit in any circumstance.
- Reliable operation and lifetime is only guaranteed if the maximum t_c point temperature is not exceeded under the conditions of use.

LED driver earthing

- LC44SEC-DA-500-1000-LOOP is Class II LED driver suitable for Class I and II luminaires, as well as driving Class III (SELV) luminaire parts in independent installation.
- If used inside **Class I** luminaires, the earth cable is not required for electrical safety in this driver. The PE connection is designed for earth signal looping between drivers.
- If used inside **Class II** luminaires, the safety of the luminaire shall be ensured through double/reinforced insulation of live parts. LC44SEC-DA-500-1000-LOOP has double/reinforced insulation between accessible and live parts, and is suitable for use in all Class II luminaires. In this case the earth terminal of the driver must be left unconnected and the luminaire terminal block shall not have any protective earthing terminal.
- If used in **independent** installation with Class I/II/III luminaires, the earth cable is not required to be connected. The PE connection is designed for earth signal looping between drivers.

Miniature Circuit Breakers (MCB)

- Type-C MCB's with trip characteristics in according to EN 60898 are recommended.
- Please see more details in "MCB information" document in each driver product page in "downloads & links" section.

Installation site

- The general preferred installation position of LED drivers for independent use is to have the top cover facing upwards.
- Minimum recommended distances below:

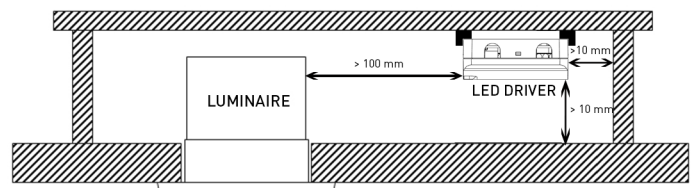
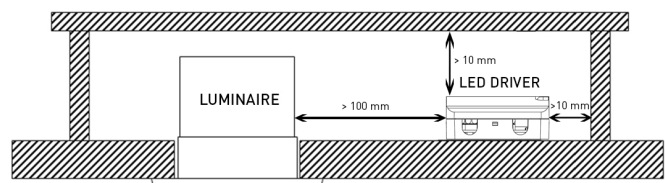

- Suitable for installation upside down and in the corner, in this case separate spacers must be used. For more information, please consult Helvar Components.

Push to Fade

Push to Fade solution includes additional fading behavior, which provides smooth transition between on and off states. Please note that Push to Fade is not compatible to be installed in the same circuit with Helvar Switch-Control or Switch-Control 2 devices. Before installation and for troubleshoot and guidance, refer to user guide at www.helvarcomponents.com.

Use of Push to Fade functionality

- Maximum numbers of LED drivers to be connected to one switch is 30.
- Ensure that all components connected to Push to Fade circuitry are mains rated.
- The transition between 0 to 100% (when turned ON / OFF) is ~ 1 second.

Lamp failure functionality

No load

When open load is detected, driver goes to standby mode and returns through mains reset.

Short circuit

When short circuit is detected, driver goes to standby mode and returns through mains reset.

Overload

When overload is detected, driver goes to standby mode and returns through mains reset.

Underload

When undervoltage is detected, driver goes to standby mode and returns through mains reset.

Conformity & standards

General and safety requirements	EN 61347-1
Particular safety requirements for DC or AC supplied electronic control gear for LED modules	EN 61347-2-13
Mains current harmonics	EN 61000-3-2
Limits for voltage fluctuations and flicker	EN 61000-3-3
Radio frequency interference	EN 55015
Immunity standard	EN 61547
Performance requirements	EN 62384
Digital addressing lighting interface:	
General requirements for DALI system	EN 62386-101 (DALI-2)
Requirements for DALI control gear	EN 62386-102 (DALI-2)
Requirements for control gear of LED modules (DALI Device Type 6)	EN 62386-207 (DALI-2)
Recommended Practices for Modulating Current in High-Brightness LEDs for Mitigating Health Risks to Viewers	IEEE 1789-2015
Compliant with relevant EU directives	
RoHS/REACH compliant	
ENEC (pending) and CE / UKCA marked	

Label symbols



Safety isolating control gear with short circuit protection (SELV control gear).



Thermally controlled control gear, incorporating means of protection against overheating to prevent the case temperature under any conditions of use from exceeding 110 °C.



DALI-2 certified control gear.



Double insulated control gear suitable for independent use.



Symbol for independent control gear.



The product is not allowed to be covered with thermally insulating material according to IEC 60598-1 (ed. 8.0)b.