

12 W SELV Dimmable DALI-2 LED driver

Product code: 5764

12 W 220 – 240 V 50 – 60 Hz

- Extremely compact dimensions (80 x 41 x 22 mm) for flexible usage
- DALI-2 certified LED driver
- SELV output protection for safety and flexibility in luminaires
- Amplitude dimming for high quality light output, 1 - 100 % dimming range
- DALI251-253 data memory banks for diagnostics and energy data
- Ideal solution for Class I and Class II



Functional Description

- Adjustable constant current output: 180 to 700 mA
- Output current setting programmable via software NFC / DALI
- Optional equipotential terminal for glow-effect removal and LED load potential balancing, see page 6 for details
- D4i compatible Smart Data features, e.g. OEM customer and luminaire data, energy reporting, diagnostics and maintenance
- Suitable for emergency lighting applications with central battery system requirements (e.g. Eaton-CEAG, Inotec). EN60598-2-22 compatibility. To enable DC operation, see page 5 for connection details
- Constant Light Output (CLO), adjustable up to 100 000 h (default disabled)
- Overload, open & short circuit protection

Mains Characteristics

Nominal rated voltage range	220 V – 240 V, 50 – 60 Hz
Rated emergency voltage range	196 V – 250 V, 0 Hz
AC voltage range	198 VAC – 264 VAC
DC voltage range	176 VDC – 280 VDC
Mains current at full load	0.06 – 0.07 A
Frequency	50 Hz – 60 Hz
Stand-by power consumption	< 0.3 W
THD at full power	< 10 %
Tested surge protection	2 kV L/N-GND (IEC 61000-4-5) 1 kV L-N (IEC 61000-4-5)
Tested fast transient protection	2 kV (IEC 61000-4-4)

Insulation between circuits & driver case

Mains circuit - SELV circuit	Double/reinforced insulation
DALI circuit - SELV circuit	Double/reinforced insulation
Mains circuit - DALI circuit	Basic insulation
Mains, DALI and output - Driver case	Double/reinforced insulation
EQUI - Mains circuit	Double/reinforced insulation
EQUI - SELV circuit	Basic insulation

Load Output (SELV <60 V)

Output current (I_{out})	180 mA (default) – 700 mA
Accuracy	± 5 %
Ripple	< 2%* at ≤ 120 Hz
*) Low frequency ripple, LED load: Cree XP-G LEDs.	
U_{out} (max) (abnormal)	60 V
EOF _I (EL use)	15 % ¹⁾
PstLM	1.0 ²⁾
SVM	0.4 ²⁾

1) By default setting, available range 1...100 % 2) Full load, LED load: Cree XP-G LEDs

I_{LED}	180 mA	300 mA	700 mA
P_{Rated}	0.15...7.2 W	1.5...12 W	3.5...12 W
U_{LED}	5 - 40 V	5 - 40 V	5 - 17 V
PF (λ) at full load	0.90	0.95	0.95
Efficiency (η) at full load	82 %	88 %	84 %

Operating window

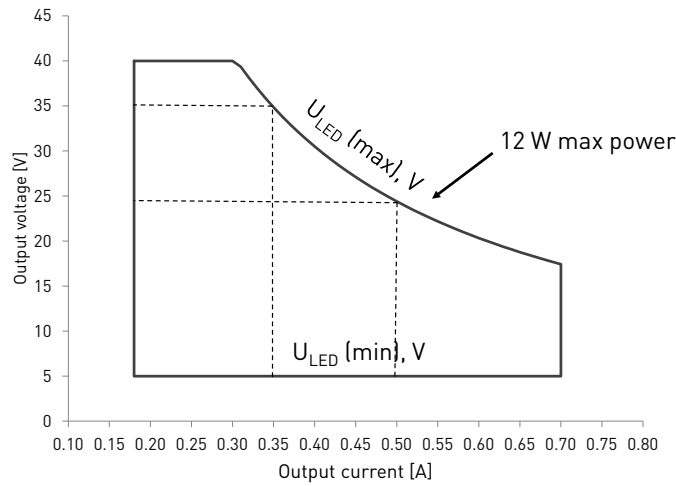

Note: Dimming between 1% - 100% possible across the operating window, restricted by the absolute minimum dimming current of 3 mA.

Driver performance

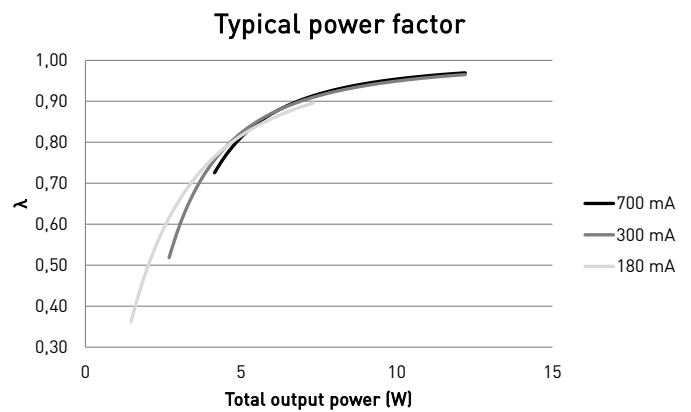
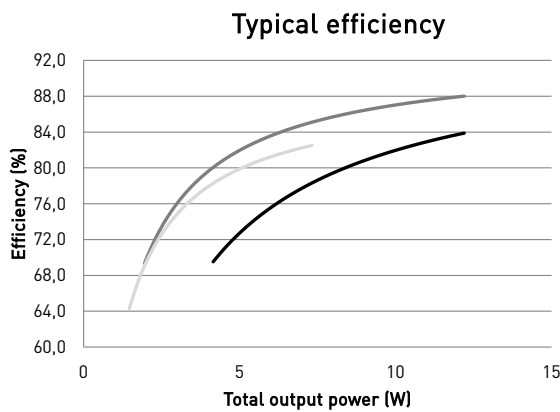

Operating Conditions and Characteristics

Absolute highest allowed t_c point temperature	85°C
T_c life (50 000 h) temperature	75°C
Ambient temperature range	-25 °C ... +50 °C ¹⁾
Storage temperature range	-40 °C ... +80 °C
Maximum relative humidity	No condensation
Life time(90 % survival rate)	100 000 h, at $t_c = 65$ °C 50 000 h, at $t_c = 75$ °C 35 000 h, at $t_c = 85$ °C

¹⁾ For other than independent use, higher t_a of the controlgear possible as long as highest allowed t_c point temperature is not exceeded

Amplitude dimming technology

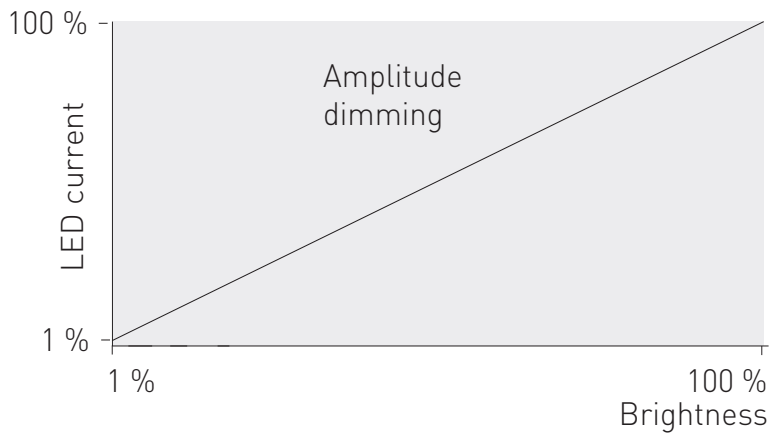

Dimming range	Dimming technology
1 % – 100 %	Amplitude (DC)

LC12TINY-DA-180-700 LED driver implements amplitude dimming technology across whole dimming range. Amplitude dimming offers the best available technology for dimming the light output in an accurate and flicker-free way to ensure high quality lighting in even the most demanding situations such as camera recording applications. Amplitude dimming technology complies with IEEE 1789-2015 recommendations of current modulation to mitigate health risks to viewers.

Wireless configuration

LC12TINY-DA-180-700 LED driver is equipped with NFC wireless technology for effortless configuration of the driver via Helvar Driver Configurator Support. Helvar Driver Configurator enables easy-to-use automatic configuration of the driver parameters via NFC, without mains or DALI connection to the driver. The most popular MD-SIG qualified NFC readers are supported giving flexibility for the operator. For further information about the usage with Helvar Driver Configurator, please see the user guide at www.helvarcomponents.com

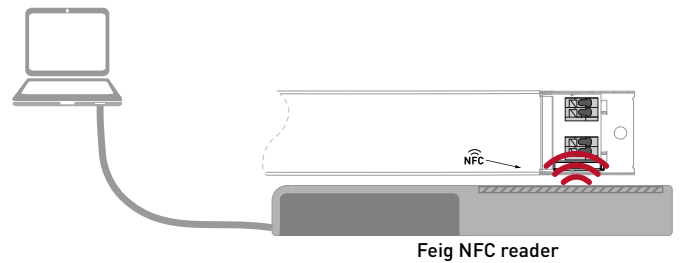

Quantity of drivers per miniature circuit breaker 16 A Type C

Based on inrush current I_{peak}	Typ. peak inrush current I_{peak}	1/2 value time, Δt	Calculated energy, $I_{peak}^2 \Delta t$
2300 pcs*	3.6 A	29 μs	0.0003 A ² s

*the inrush current is not the limiting factor for the products per MCB, please notice the continuous current limitations.

CONVERSION TABLE FOR OTHER TYPES OF MINIATURE CIRCUIT BREAKER

MCB type	Relative quantity of LED drivers
B 10 A	37 %
B 16 A	60 %
B 20 A	75 %
C 10 A	62 %
C 16 A	100 % (see table above)
C 20 A	125 %

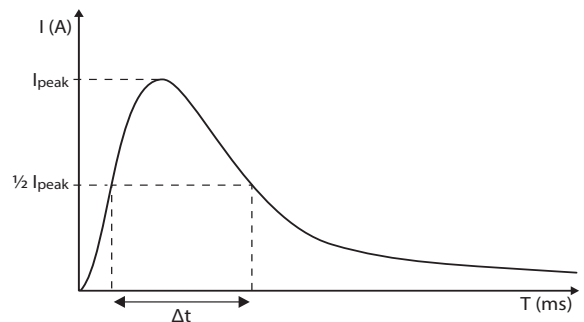

CONTINUOUS CURRENT

Total continuous current of the drivers and installation environment must always be considered and taken into calculations when installing drivers behind miniature circuit breaker. Example calculation of total drivers amount limited by continuous current: $n(I_{cont}) = [16 A (I_{nom,Ta}) / \text{“nominal mains current with full load”}] \times 0.76$. This calculation is an example according to recommended precautions due to multiple adjacent circuit breakers (> 9 MCBs) and installation environment (T_a 30 degrees); variables may vary according to the use case. Both inrush current and continuous current calculations are based on ABB S200 series circuit breakers. More specific information in ABB series S200 circuit breaker documentation.

NOTE! Type C MCB's are strongly recommended to use with LED lighting. Please see more details in "MCB information" document in each driver product page in "downloads & links" section.

DC emergency lighting functionality

When AC supply is switched to DC, the LED driver will recognise this and switch to emergency lighting mode. The light level will be adjusted to 15 % of the nominal AC operation output current by default. The DC light level cannot be adjusted or turned off, unless “DC dimming” is specifically enabled through Helvar Driver Configurator. When the AC is switched back on, the driver returns to normal operation. The internal temperature protection feature can never force the light level off or below the set emergency level in DC mode.

Internal thermal protection

This LED driver has built-in active internal thermal protection. This feature protects the LED driver by limiting the maximum output current within one minute fade time when the temperature rises enough above the specified operating environment of the driver. If the temperature exceeds a certain predefined critical point, the output will be switched off and returns automatically once the temperature decreases below the threshold. The default behavior is shown in the graph on the right.

By factory default,

- The internal thermal protection is enabled
- The derating temperature point is set to 90°C
- Derating level to 30 %
- Shutdown temperature point to 110°C

Note that the internal measured temperature does not equal T_c temperature of the driver!

Internal thermal protection feature can be either disabled or manually adjusted to trigger earlier if desired. Configuring the internal thermal protection is done via Helvar Driver Configurator.

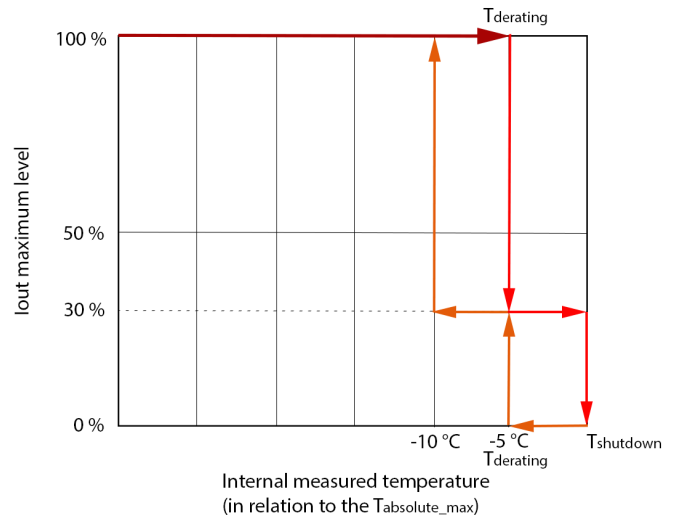

D4i-compatible Smart Data Features (DALI 251-253)

LC12TINY-DA-180-700 LED driver has integrated Smart Data features, which monitor, gather and provide key data about the LED driver usage and internal parameters through DALI. This useful data provided by LED driver enables various applications and integrations into data management and IoT services, establishing the Helvar Components LED drivers as key components in the latest generation of smart luminaires.

The DALI parts 251-253 include:

- OEM Customer data (DALI part 251)
- Energy reporting (DALI part 252)
- Diagnostics and maintenance (DALI part 253)

Connections and Mechanical Data

Wire size	0.5 mm ² – 1.5 mm ²
Wire type	Solid core and fine-stranded
Wire insulation	According to EN 60598
Maximum driver to LED wire length	1.5 m
Weight	59 g
IP rating	IP20

Connections

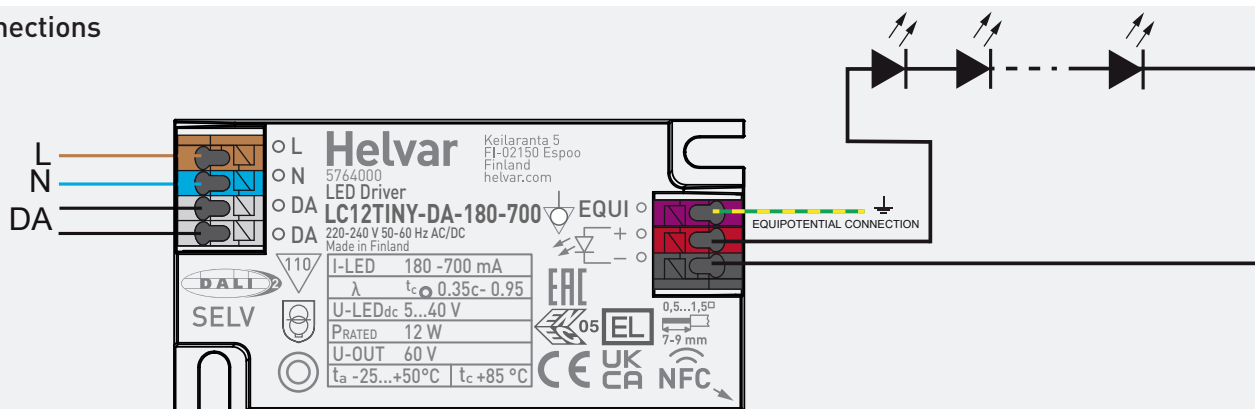

Note:

- Not suitable for load side switching operation
- For DC emergency operation, the Line (L) and Neutral (N) MUST be connected in the correct order as shown in image above.
- The Equipotential terminal (EQUI) can be used for glow effect removal or reducing potential differences. It is optional to connect.

Dimensions (mm)

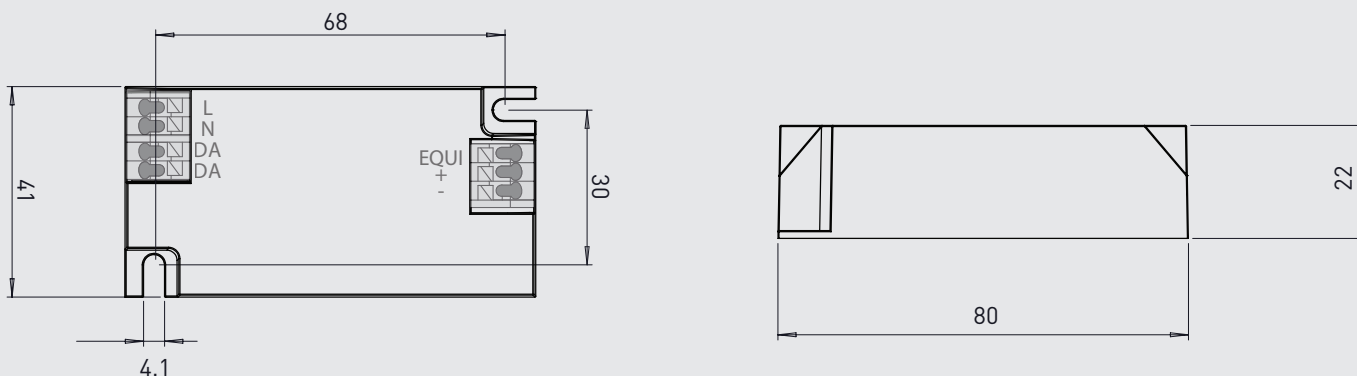

LC12TINY-DA-180-700 LED driver is suited for built-in usage in luminaires. In order to have safe and reliable LED driver operation, the LED luminaires will need to comply with the relevant standards and regulations (e.g. IEC/EN 60598-1). The LED luminaire shall be designed to adequately protect the LED driver from dust, moisture and pollution. The luminaire manufacturer is responsible for the correct choice and installation of the LED drivers according to the application and product datasheets. Operating conditions of the LED drivers may never exceed the specifications as per the product datasheet.

Installation & operation

Maximum ambient and t_c temperature:

- For built-in components inside luminaires, the t_a ambient temperature range is a guideline given for the optimum operating environment. However, integrator must always ensure proper thermal management (i.e. mounting base of the driver, air flow etc.) so that the t_c point temperature does not exceed the t_c maximum limit in any circumstance.
- Reliable operation and lifetime is only guaranteed if the maximum t_c point temperature is not exceeded under the conditions of use.

Miniature Circuit Breakers (MCB)

- Type-C MCB's with trip characteristics in according to EN 60898 are recommended.
- Please see more details in "MCB information" document in each driver product page in "downloads & links" section.

EQUI terminal

- EQUI terminal is optional connection to be connected to LED module and other metal parts of luminaire. This gives the LED modules additional protection against high voltage potential differences, when the metal parts are all connected to same ground potential.
- EQUI terminal connection can also be used for glow effect removal

Functionality in abnormal conditions

No load

When open load is detected, the driver will go to standby mode and remain in automatic recovery status. In automatic recovery mode, the driver will check every four seconds if the load has been reconnected. Once that happens, it returns to normal operation.

Short circuit (/underload)

When short circuit is detected, driver will go to standby mode. It will return to normal operation through DALI light level OFF -> ON command or through mains reset.

Overload

When overload/voltage is detected, driver will act similarly to no load situation, it will go to standby mode and remain in automatic recovery status. In automatic recovery mode, the driver will check every four seconds if the load has been reconnected. Once that happens, it returns to normal operation.

Internal overtemperature

When the driver exceeds the T_c max operating temperature, soon above that point the driver will start decreasing the maximum output current. Details about the operation in page 3 "Internal Thermal Protection"

AC to DC emergency lighting mode

When AC supply is switched to DC, the LED driver will recognise this and switch to emergency lighting mode. Details about the operation in page 3 "DC emergency lighting functionality".

NOTE! For DC functionality to work correctly, Line (L) must be connected to brown connector and Neutral (N) to blue connector.

Conformity & standards

General and safety requirements	EN 61347-1
Particular safety requirements for DC or AC supplied electronic control gear for LED modules	EN 61347-2-13
Additional safety requirements for AC or DC supplied electronic controlgear for emergency lighting	EN 61347-2-13, Annex J
Thermal protection class	EN 61347, C5e
Mains current harmonics	EN IEC 61000-3-2
Limits for voltage fluctuations and flicker	EN 61000-3-3
Radio frequency interference	EN IEC 55015
Immunity standard	EN 61547
Performance requirements	EN IEC 62384
Digital addressing lighting interface:	
General requirements for DALI system	EN 62386-101 (DALI-2)
Requirements for DALI control gear	EN 62386-102 (DALI-2)
Requirements for control gear of LED modules (DALI Device Type 6)	EN 62386-207 (DALI-2)
Memory Bank 1 extension	DALI Part 251
Energy Reporting	DALI Part 252
Diagnostics & Maintenance	DALI Part 253
Recommended Practices for Modulating Current in High-Brightness LEDs for Mitigating Health Risks to Viewers	IEEE 1789-2015
Compliant with relevant EU directives	
RoHS/REACH compliant	
ENEC and CE / UKCA marked	

Label symbols



Safety isolating control gear with short circuit protection (SELV control gear).



Double insulated control gear suitable for built-in use.



Thermally controlled control gear, incorporating means of protection against overheating to prevent the case temperature under any conditions of use from exceeding 110 °C.



DALI-2 certified control gear.



AC/DC supplied electronic control gear for emergency lighting purposes intended for connection to a centralized emergency power supply.



Equipotential terminal for glow effect removal and equalising the potential difference in LED modules.