

## 37.8 W **SELV constant current** LED driver

Product code: 5923

**37.8 W 220 – 240 V 50 – 60 Hz**

- SELV output protection for safety and flexibility in luminaires
- High efficiency up to 88 %
- Low current ripple, complying with IEEE 1789 recommendation
- Compact dimensions for flexible usage
- Ideal solution for Class I and Class II luminaires
- For driving Class III (SELV) luminaires, optional strain relief for independent use outside of luminaire (LC-SR-MINI or LC-SR-MINI-B)

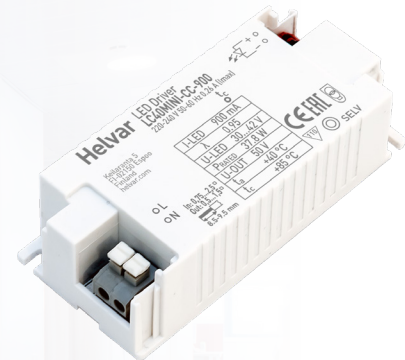

### Functional Description

- Constant current output: 900 mA
- Overload, open & short circuit protection

### Mains Characteristics

Nominal rated voltage range	220 V – 240 V, 50 – 60 Hz
AC voltage range	198 VAC – 264 VAC
Mains current at full load	0.26 A
Frequency	50 Hz – 60 Hz
Stand-by power consumption	< 0.5 W
THD at full power	< 10 %
Tested surge protection	1 kV L-N (IEC 61000-4-5) 2 kV L/N-GND (IEC 61000-4-5)
Tested fast transient protection	1 kV (IEC 61000-4-4)

### Insulation between circuits & driver case

Mains circuit - SELV circuit	Double/reinforced insulation
Mains and output - Driver case	Double/reinforced insulation

### Load Output (SELV <60 V)

Output current ( $I_{out}$ )	900 mA
Accuracy	± 5 %
Ripple	< ±3 % <sup>1)</sup> at ≤ 120 Hz
PstLM	< 0.03 <sup>2)</sup>
SVM	< 0.01 <sup>2)</sup>
$U_{out}$ (max) (abnormal)	50 V

1) Low frequency  
2) At full power, measured with Cree XP-G LED modules.

$I_{LED}$	900 mA
$P_{Rated}$	37.8 W
$U_{LED}$	30 - 42 V
PF ( $\lambda$ ) at full load	0.95
Efficiency ( $\eta$ ) at full load	88 %

## Operating window

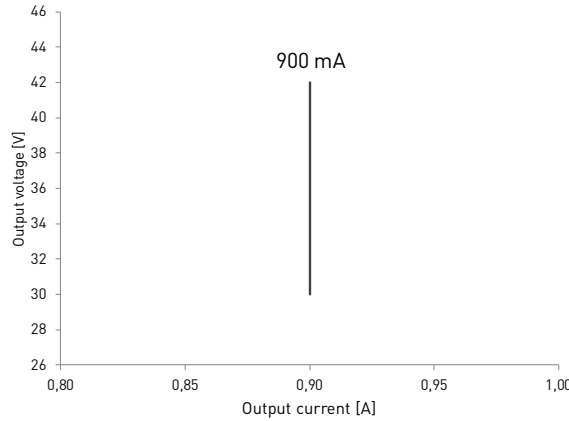

## Driver performance

Typical efficiency

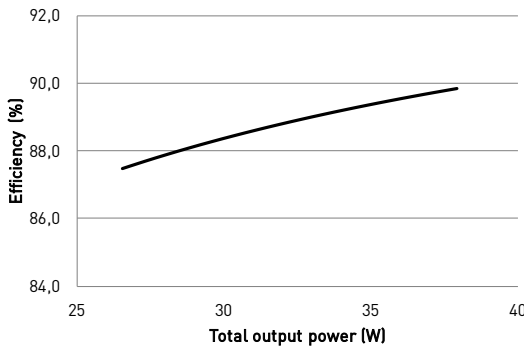

Typical power factor

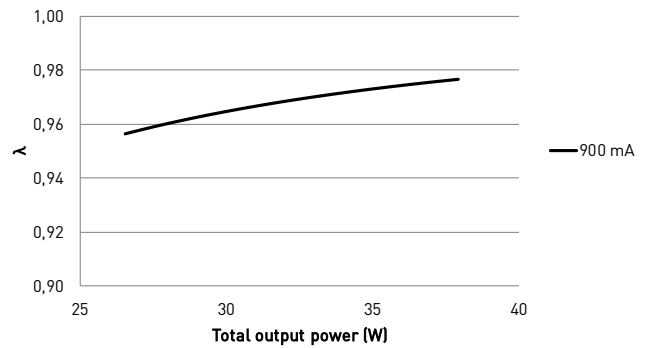

## Operating Conditions and Characteristics

Absolute highest allowed $t_c$ point temperature	85 °C
Tc life (50 000 h) temperature	85 °C
Ambient temperature range*	-25 °C ... +40 °C*
Storage temperature range	-25 °C ... +60 °C
Maximum relative humidity	No condensation
Mains switching cycles	> 100 000 cycles
Life time (90 % survival rate)	50 000 h, at $t_c = 85$ °C

\*) For other than independent use, higher  $t_a$  of the controlgear possible as long as highest allowed  $t_c$  point temperature is not exceeded

## Quantity of drivers per miniature circuit breaker 16 A Type C

Based on inrush current $I_{peak}$	Typ. peak inrush current $I_{peak}$	1/2 value time, $\Delta t$
37 pcs.	30 A	200 $\mu$ s

### CONVERSION TABLE FOR OTHER TYPES OF MINIATURE CIRCUIT BREAKER

MCB type	Relative quantity of LED drivers
B 10 A	37 %
B 16 A	60 %
B 20 A	75 %
C 10 A	62 %
C 16 A	100 % (see table above)
C 20 A	125 %

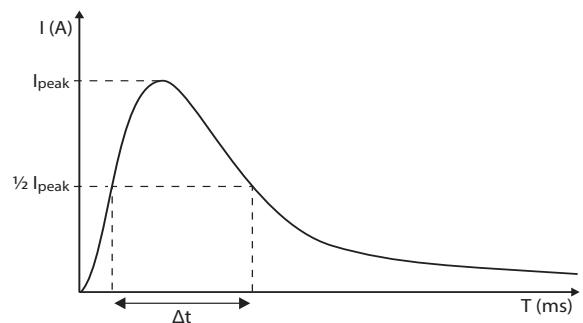

## CONTINUOUS CURRENT

Total continuous current of the drivers and installation environment must always be considered and taken into calculations when installing drivers behind miniature circuit breaker. Example calculation of total drivers amount limited by continuous current:  $n(I_{cont}) = [16 A (I_{nom,Ta}) / \text{"nominal mains current with full load"}] \times 0.76$ . This calculation is an example according to recommended precautions due to multiple adjacent circuit breakers (> 9 MCBs) and installation environment ( $T_a$  30 degrees); variables may vary according to the use case. Both inrush current and continuous current calculations are based on ABB S200 series circuit breakers. More specific information in ABB series S200 circuit breaker documentation.

NOTE! Type C MCB's are strongly recommended to use with LED lighting. Please see more details in "MCB information" document in each driver product page in "downloads & links" section.

## Connections and Mechanical Data

Wire size	Input: 0.75 mm <sup>2</sup> – 2.5 mm <sup>2</sup>
Wire type	Output: 0.5 mm <sup>2</sup> – 1.5 mm <sup>2</sup>
Wire insulation	Solid core and fine-stranded
Maximum driver to LED wire length	According to EN 60598
Weight	1.5 m
IP rating	96 g
	IP20

## Connections

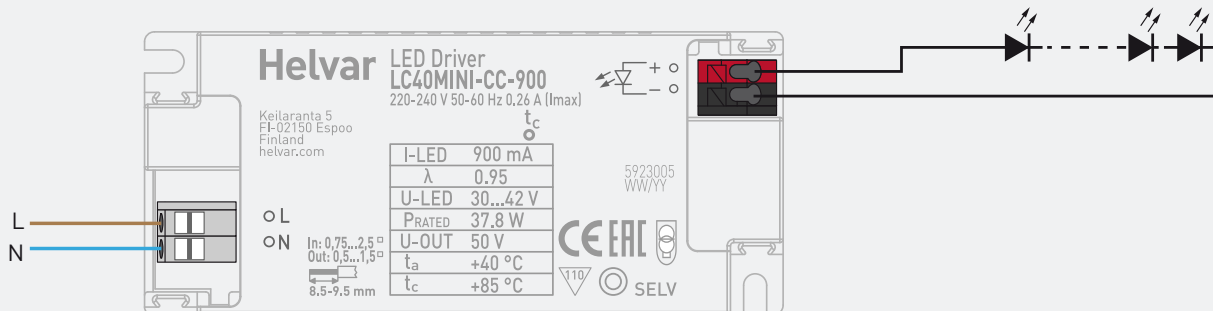

Note:

- Not suitable for load side switching operation

## Dimensions (97 x 43 x 26 mm)

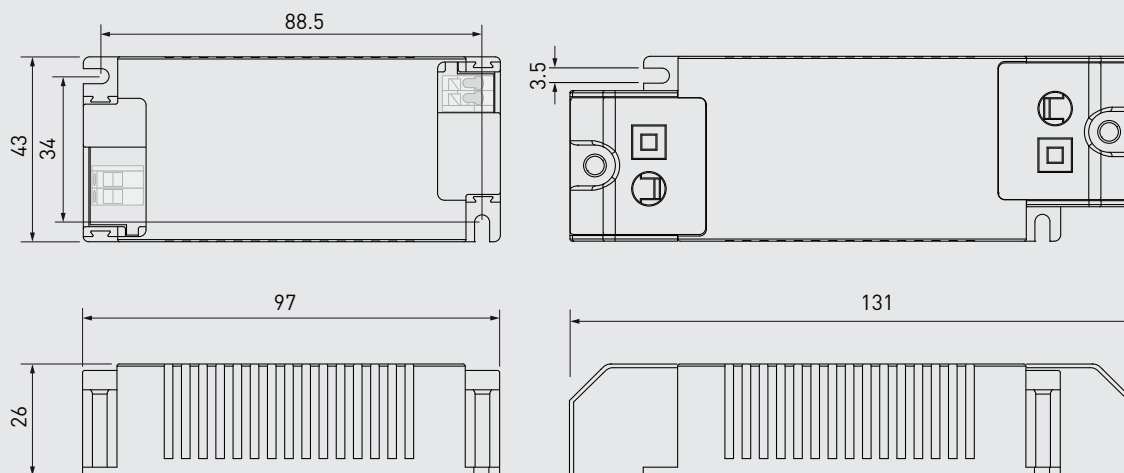

LC40MINI-CC-900 LED driver is suited for built-in usage in luminaires. With external strain relief (LC-SR-MINI or LC-SR-MINI-B), independent use is possible too. In order to have safe and reliable LED driver operation, the LED luminaires will need to comply with the relevant standards and regulations (e.g. IEC/EN 60598-1). The LED luminaire shall be designed to adequately protect the LED driver from dust, moisture and pollution. The luminaire manufacturer is responsible for the correct choice and installation of the LED drivers according to the application and product datasheets. Operating conditions of the LED drivers may never exceed the specifications as per the product datasheet.

## Installation & operation

### Maximum ambient and $t_c$ temperature:

- For built-in components inside luminaires, the  $t_a$  ambient temperature range is a guideline given for the optimum operating environment. However, integrator must always ensure proper thermal management (i.e. mounting base of the driver, air flow etc.) so that the  $t_c$  point temperature does not exceed the  $t_c$  maximum limit in any circumstance.
- Reliable operation and lifetime is only guaranteed if the maximum  $t_c$  point temperature is not exceeded under the conditions of use.

### Miniature Circuit Breakers (MCB)

- Type-C MCB's with trip characteristics in according to EN 60898 are recommended.
- Please see more details in "MCB information" document in each driver product page in "downloads & links" section.

### Installation site

- The general preferred installation position of LED drivers for independent use is to have the top cover facing upwards.

## Lamp failure functionality

### No load

When open load is detected, driver limits output voltage according to  $U_{out} (max)$  (abnormal).

### Overload

Driver can withstand overload, however reliable operation is only guaranteed in specified voltage range.

### Short circuit

Driver can withstand output short circuit.

## Conformity & standards

General and safety requirements	EN 61347-1
Particular safety requirements for DC or AC supplied electronic control gear for LED modules	EN 61347-2-13
Mains current harmonics	EN 61000-3-2
Limits for voltage fluctuations and flicker	EN 61000-3-3
Radio frequency interference	EN 55015
Immunity standard	EN 61547
Performance requirements	EN 62384
Recommended Practices for Modulating Current in High-Brightness LEDs for Mitigating Health Risks to Viewers	IEEE 1789-2015
Compliant with relevant EU directives	
RoHS / REACH compliant	
CE / UKCA marked	

## Label symbols



Safety isolating control gear with short circuit protection (SELV control gear).



Double insulated control gear suitable for built-in use.



Thermally controlled control gear, incorporating means of protection against overheating to prevent the case temperature under any conditions of use from exceeding 110 °C.