

## 42 W SELV Dimmable DALI-2 LED driver

Product code: 5965xxx (see last page)

42 W 220 – 240 V 0 / 50 – 60 Hz

- DALI-2 certified LED driver, 1-100 % dimming range
- Extremely compact and slim 22 mm high mechanics
- High efficiency up to 91 %
- Amplitude dimming technology for the highest quality light output, complying with IEEE 1789 recommendations
- D4i compatible Smart Data features (DALI 251-253)
- Wide output current and output voltage range
- Suitable for use in emergency lighting applications
- For driving Class III (SELV) luminaires, optional strain reliefs for independent use outside of luminaire (LC-SR-MN22 or LC-SR-MN22-LOOP)\*



\*See also last page.



### Functional Description

- Adjustable constant current output: 300 mA to 1050 mA (default)
- Current setting via with DIP switches
- Long lifetime up to 100 000 hours
- Potted casing for improved durability
- Amplitude dimming technology for the highest quality light in every application
- D4i compatible Smart Data features, e.g. OEM customer and luminaire data, energy reporting, diagnostics and maintenance
- Push to Fade functionality for easy-to-use intensity control with smooth fade in transitions
- Suitable for flicker-free camera recording applications
- Overload, open & short circuit protection

### Mains Characteristics

Nominal rated voltage range	220 V – 240 V, 50 – 60 Hz
Rated emergency voltage range*	198-254 VDC
AC voltage range	198-264 VAC
DC voltage range	180-280 VDC
Mains current at full load	0.25 A
Frequency	50 Hz – 60 Hz
Stand-by power consumption	< 0.4 W
THD at full power	< 7 %
Tested surge protection	1 kV L-N (IEC 61000-4-5) 2 kV L/N-GND (IEC 61000-4-5)
Tested fast transient protection	1 kV (IEC 61000-4-4)

\*) For emergency use, see page 5 for details

### Insulation between circuits & driver case

Mains circuit - SELV circuit	Double/reinforced insulation
DALI circuit - SELV circuit	Double/reinforced insulation
Mains circuit - DALI circuit	Basic insulation
Mains, DALI and output - Driver case	Double/reinforced insulation

### Load Output (SELV <60 V)

Output current ( $I_{out}$ )	300 mA – 1050 mA (default)
Accuracy	$\pm 5 \%$
Ripple	$< \pm 3 \%$ <sup>1)</sup> at $\leq 120$ Hz
PstLM	$< 0.05$ <sup>2)</sup>
SVM	$< 0.01$ <sup>2)</sup>
$U_{out}$ (max) (abnormal)	60 V
EOFx (EL use)	15 %

1) Low frequency, LED load: Cree XP-G LEDs  
2) At full power, measured with Cree XP-G LED modules.

$I_{LED}$	300 mA	800 mA	1050 mA
$P_{Rated}$	15.6 W	41.6 W	42 W
$U_{LED}$	2.5 – 52 V	2.5 – 52 V	2.5 – 40 V
PF ( $\lambda$ ) at full load	0.92	0.98	0.98
Efficiency ( $\eta$ ) at full load	89 %	91 %	90 %

## Operating window and driver performance

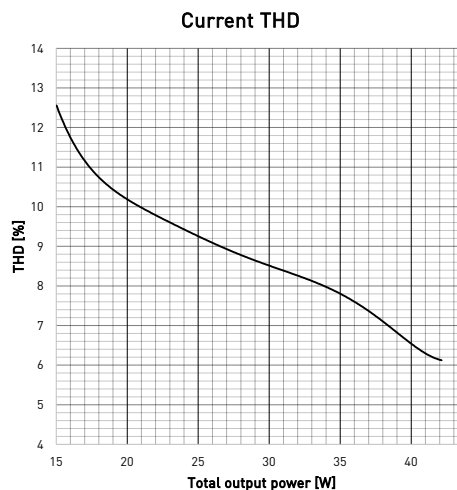
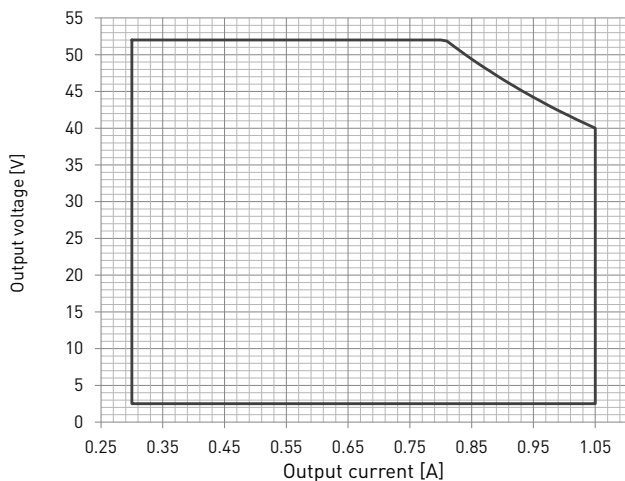

1) Dimming between 1 - 100 % possible accros the operating window, restricted by the absolute minimum dimming current of 3.5 mA  
 2) Current value is adjustable in steps via DIP switch. See DIP switch settings in page 5 for details.

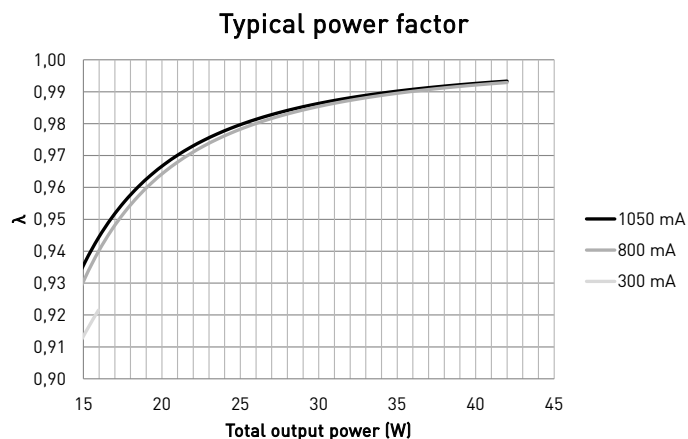
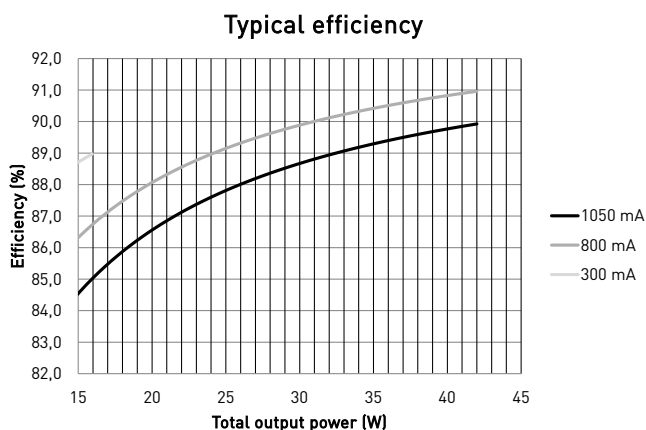

## Operating Conditions and Characteristics

Absolute highest allowed $t_c$ point temperature	90 °C
Tc life (50 000 h) temperature	80 °C
Ambient temperature range	-20 °C .. +45 °C*
Storage temperature range	-40 °C ... +80 °C
Maximum relative humidity	No condensation
Life time (90 % survival rate)	100 000 h, at $t_c = 68^\circ\text{C}$ 70 000 h, at $t_c = 75^\circ\text{C}$ 50 000 h, at $t_c = 80^\circ\text{C}$

\*) For other than independent use, higher  $t_s$  of the controlgear possible as long as highest allowed  $t_c$  point temperature is not exceeded

## Amplitude dimming technology

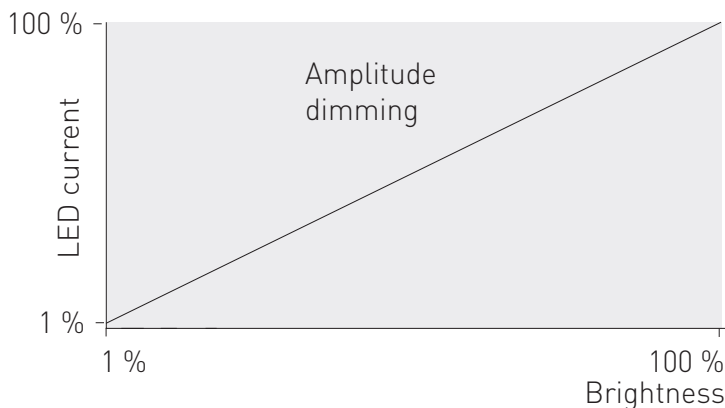

Dimming range	Dimming technology
1 % – 100 %	Amplitude (DC)

LC43MN22-DA-300-1050 LED driver implements amplitude dimming technology across whole dimming range. Amplitude dimming offers the best available technology for dimming the light output in an accurate and flicker-free way to ensure high quality lighting in even the most demanding situations such as camera recording applications. Amplitude dimming technology complies with IEEE 1789-2015 recommendations of current modulation to mitigate health risks to viewers.

## Quantity of drivers per miniature circuit breaker 16 A Type C

Based on inrush current $I_{peak}$	Typ. peak inrush current $I_{peak}$	1/2 value time, $\Delta t$	Calculated energy, $I_{peak}^2 \Delta t$
230 pcs*	5 A	45 $\mu s$	0.220 A <sup>2</sup> s

\*Inrush current is not the limiting factor for the products per C 16 A MCB, please notice the continuous current limitations.

## CONVERSION TABLE FOR OTHER TYPES OF MINIATURE CIRCUIT BREAKERS

MCB type	Relative quantity of LED drivers
B 10 A	37 %
B 16 A	60 %
B 20 A	75 %
C 10 A	62 %
C 16 A	100 % (see table above)
C 20 A	125 %

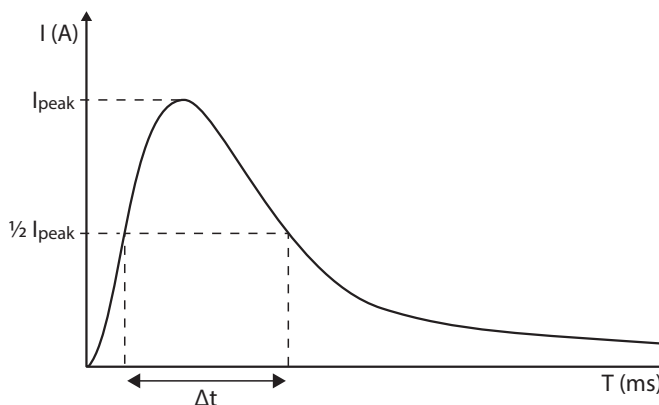

## CONTINUOUS CURRENT

Total continuous current of the drivers and installation environment must always be considered and taken into calculations when installing drivers behind miniature circuit breaker. Example calculation of total drivers amount limited by continuous current:  $n(I_{cont}) = (16 A (I_{nom, Ta} / \text{"nominal mains current with full load"} \times 0.76))$ . This calculation is an example according to recommended precautions due to multiple adjacent circuit breakers (> 9 MCBs) and installation environment ( $T_a$  30 degrees); variables may vary according to the use case. Both inrush current and continuous current calculations are based on ABB S200 series circuit breakers. More specific information in ABB series S200 circuit breaker documentation.

NOTE! Type C MCB's are strongly recommended to use with LED lighting. Please see more details in "MCB information" document in each driver product page in "downloads & links" section.

## Connections and Mechanical Data

Wire size	0.5 mm <sup>2</sup> – 1.5 mm <sup>2</sup>
Wire type	Solid core and fine-stranded
Wire insulation	According to EN 60598
Maximum driver to LED wire length	1.5 m
Weight	110 g
IP rating	IP20

## Connections

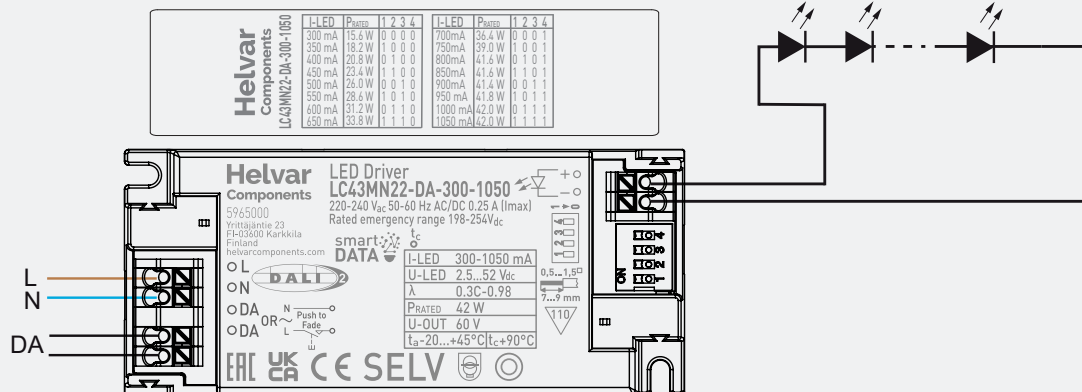

Note:

- Not suitable for load side switching operation

## Dimensions (mm)

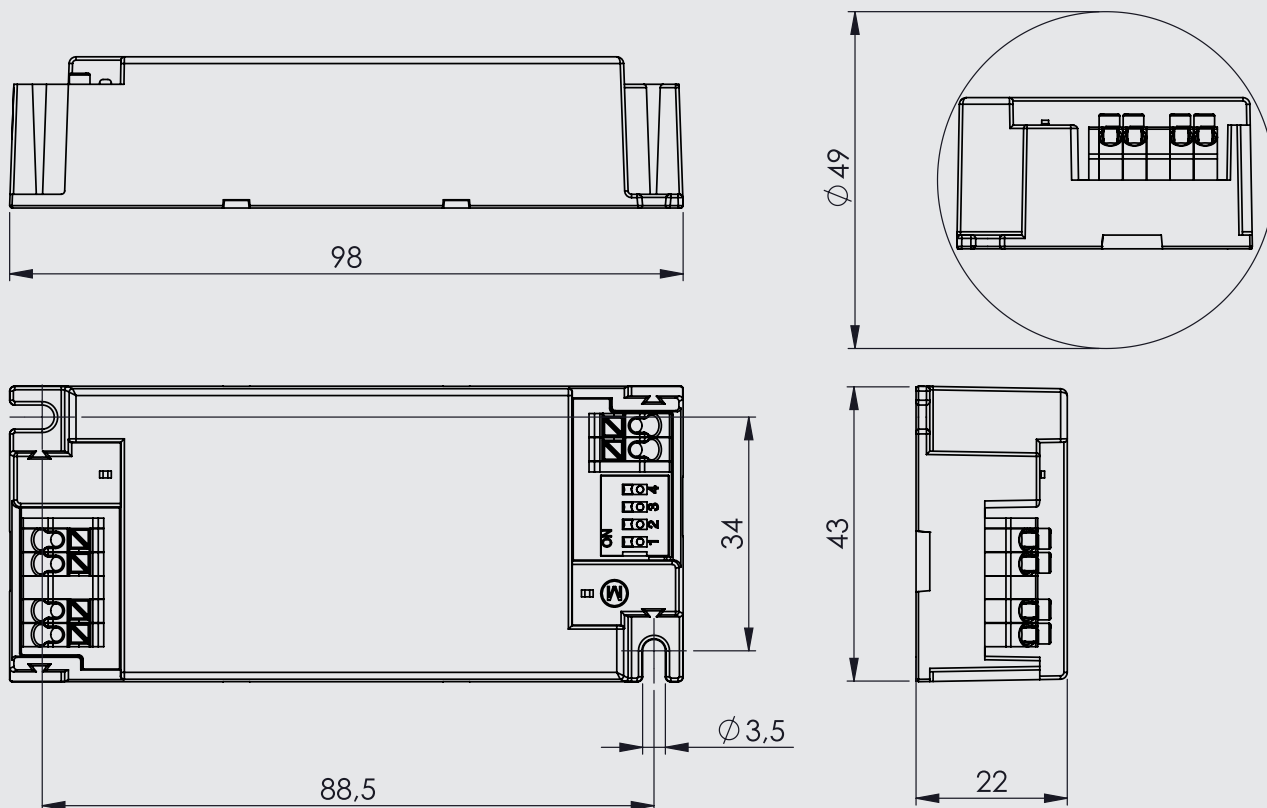

## D4i-compatible Smart Data Features (DALI 251-253)

LC43MN22-DA-300-1050 driver has integrated Smart Data features, which monitor, gather and provide key data about the LED driver usage and internal parameters through DALI. This useful data provided by LED driver enables various applications and integrations into data management and IoT services, establishing the Helvar Components LED drivers as key components in the latest generation of smart luminaires.

The DALI parts 251-253 include:

- OEM Customer data (DALI part 251)
- Energy reporting (DALI part 252)
- Diagnostics and maintenance (DALI part 253)

The data from these databanks can be accessed and read through DALI bus with the Helvar Driver Configurator.

In LC43MN22-DA-300-1050, the current can be set with DIP switches. With each combination of switch setup, a different output current value can be set. The maximum value can be reached with the DIP switch setting presented below and minimum with all switches set to "0" (pushed away from the LED driver label, see connections picture above). The output current values according to the DIP switch settings are presented below.

### DIP switch combinations and currents (Nominal $I_{out}$ ( $\pm 5\%$ tol.))

DIP switch combination	1111	0111	1011	0011	1101	0101	1001	0001
$I_{out}$ (mA)	1050	1000	950	900	850	800	750	700
Voltage range	2.5 - 40 V	2.5 - 42 V	2.5 - 44 V	2.5 - 46 V	2.5 - 49 V	2.5 - 52 V	2.5 - 52 V	2.5 - 52 V
DIP switch combination	1110	0110	1010	0010	1100	0100	1000	0000
$I_{out}$ (mA)	650	600	550	500	450	400	350	300
Voltage range	2.5 - 52 V	2.5 - 52 V	2.5 - 52 V	2.5 - 52 V	2.5 - 52 V	2.5 - 52 V	2.5 - 52 V	2.5 - 52 V

## Information and conformity

LC43MN22-DA-300-1050 LED driver is suited for built-in usage in luminaires. With external strain relief (LC-SR-MN22 or LC-SR-MN22-LOOP), independent use is possible too. In order to have safe and reliable LED driver operation, the LED luminaires will need to comply with the relevant standards and regulations (e.g. IEC/EN 60598-1). The LED luminaire shall be designed to adequately protect the LED driver from dust, moisture and pollution. The luminaire manufacturer is responsible for the correct choice and installation of the LED drivers according to the application and product datasheets. Operating conditions of the LED drivers may never exceed the specifications as per the product datasheet.

### Installation & operation

#### Maximum ambient and $t_c$ temperature:

- For built-in components inside luminaires, the  $t_a$  ambient temperature range is a guideline given for the optimum operating environment. However, integrator must always ensure proper thermal management (i.e. mounting base of the driver, air flow etc.) so that the  $t_c$  point temperature does not exceed the  $t_c$  maximum limit in any circumstance.
- Reliable operation and lifetime is only guaranteed if the maximum  $t_c$  point temperature is not exceeded under the conditions of use.

#### Current setting via DIP switch

LC43MN22-DA-300-1050 LED driver features a constant current output adjustable via DIP switch combinations.

- For the combination/current values, refer to the table above.

#### Emergency use

- The product can be continuously operated only with AC, the DC is reserved only for emergency usage.

## Miniature Circuit Breakers (MCB)

- Type-C MCB's with trip characteristics in according to EN 60898 are recommended.
- Please see more details in "MCB information" document in each driver product page in "downloads & links" section.

## Lamp failure functionality

### No load

When open load is detected, the driver goes to standby and returns through mains reset.

### Overload

The driver can withstand output overload. When overload occurs, the driver goes to standby and returns through mains reset.

### Short circuit

The driver can withstand output short circuit. When short circuit occurs, the driver goes to standby and returns through mains reset.

### AC to DC emergency lighting mode

When AC supply is switched to DC, driver will recognise this and switch to emergency lighting mode. The light level will be adjusted to 15 % of the nominal AC operation output current. The DC light level cannot be adjusted or turned off by manual control. When the AC is switched back on, the driver returns to normal operation.

## Push to Fade

Push to Fade solution includes additional fading behavior, which provides smooth transition between on and off states. Please note that Push to Fade is not compatible to be installed in the same circuit with Helvar Switch-Control or Switch-Control 2 devices.

Before installation and for troubleshoot and guidance, refer to user guide at [www.helvarcomponents.com](http://www.helvarcomponents.com).

### Use of Push to Fade functionality

- Maximum numbers of LED drivers to be connected to one switch is 30.
- Ensure that all components connected to Push to Fade circuitry are mains rated.
- The transition between 0 to 100% (when turned ON / OFF) is ~ 1 second.

## Conformity & standards

General and safety requirements	EN 61347-1
Particular safety requirements for DC or AC supplied electronic control gear for LED modules	EN 61347-2-13
Additional safety requirements for AC or DC supplied electronic controlgear for emergency lighting	EN 61347-2-13, Annex J
Thermal protection class	EN 61347, C5e
Mains current harmonics	EN 61000-3-2
Limits for voltage fluctuations and flicker	EN 61000-3-3
Radio frequency interference	EN 55015
Immunity standard	EN 61547
Performance requirements	EN 62384
<b>Digital addressing lighting interface:</b>	
General requirements for DALI system	EN 62386-101 (DALI-2)
Requirements for DALI control gear	EN 62386-102 (DALI-2)
Requirements for control gear of LED modules (DALI Device Type 6)	EN 62386-207 (DALI-2)
Memory Bank 1 extension	DALI Part 251
Energy Reporting	DALI Part 252
Diagnostics & Maintenance	DALI Part 253
Recommended Practices for Modulating Current in High-Brightness LEDs for Mitigating Health Risks to Viewers	IEEE 1789-2015
Compliant with relevant EU directives	
RoHS/REACH compliant	
ENEC (pending) and CE/UKCA marked	

## Label symbols



Safety isolating control gear with short circuit protection (SELV control gear).



Double insulated control gear suitable for built-in use.



Thermally controlled control gear, incorporating means of protection against overheating to prevent the case temperature under any conditions of use from exceeding 110 °C.



DALI-2 certified control gear.



(Pending) AC/DC supplied electronic control gear for emergency lighting purposes intended for connection to a centralized emergency power supply.

LC43MN22-DA-300-1050 LED driver can be ordered as just the built-in LED driver itself or then as a combination package with strain reliefs for input and output side. Input strain relief is a LOOPing model with the connector block inside, output strain relief is simple model with screw tightening. Everything is preassembled from the factory, ready to be connected to your LED luminaire! Please refer to the order codes in the table below.

## ORDER CODES

	Order code	Product name	What is included
<i>LC43MN22-DA-300-1050</i>			
<b>Product order codes</b>	5965000	LC43MN22-DA-300-1050	LC43MN22-DA-300-1050 LED driver
	5965010	LC43MN22-DA-300-1050-SR	LC43MN22-DA-300-1050 LED driver and 2 x LC-SR-MN22 strain reliefs (input + output), preassembled
	5965020	LC43MN22-DA-300-1050-LOOP-A	LC43MN22-DA-300-1050 LED driver and LC-SR-MN22-LOOP + LC-SR-MN22 strain reliefs (input + output), preassembled
	5966100	LC-SR-MN22	1 x Strain relief, screwable
	5966300	LC-SR-MN22-LOOP	1 x Strain relief, LOOP model

