

45 W Constant Voltage DALI-2 LED driver

Product code: 5939

45.1 W 220-240 VAC 0 / 50-60 Hz

- 24 V Constant voltage output
- DALI-2 certified LED driver, 1-100 % dimming range
- Very low voltage ripple and high-quality dimming, complying with IEEE 1789-2015 recommendation
- Integrated strain reliefs with screwless clamps for simple and efficient installation process for many cable types
- Suitable for emergency lighting use
- Driver protection Class II, suitable for Class I / II luminaires
- Suitable for independent use with integrated strain reliefs
- SELV output for driving Class III luminaires



Functional Description

- In-built overvoltage protection, open circuit protection and short circuit protection
- DALI-2 certified, 1 - 100 % dimming range
- Push to Fade functionality for easy-to-use intensity control with smooth fade in transitions
- 24 V constant voltage output

Mains Characteristics

Nominal rated voltage range	220 V – 240 V, 0 / 50 – 60 Hz
AC Voltage range	198 – 264 VAC
DC voltage range	176 – 280 VDC
DC starting voltage	> 190 VDC
Mains current at full load	Max. 0.35 A
Frequency	50 - 60 Hz
Input Power at no load	< 0.5 W
THD at full power	< 10%
Tested surge protection	1 kV L-N
Typical peak inrush current	40 A*

* See the MCB chart on page 2 for more details

Insulation between circuits & driver case

Mains circuit - Output (SELV) circuit	Double / reinforced insulation
Input and output - Driver case	Double / reinforced insulation

Load Output

Output voltage (U_{LED})	24 V
Accuracy	$\pm 5 \%$
Ripple	< 1 %* at ≤ 120 Hz *] Low frequency, measured at full load, 240 VAC
PstLM	$\leq 1^*$
SVM	$\leq 0.4^*$ *] At full power

U_{out} (max)	25 V
Max output current (I_{LED})	1.88 A
Max output power	45.1 W
EOFx (EL use)	15 %

U_{LED}	24 V
P_{Rated}	45.1 W
I_{LED} (max)	1.88 A
PF (λ) at full load	> 0.95
Efficiency (η) at full load	> 87 %

Operating window & driver performance

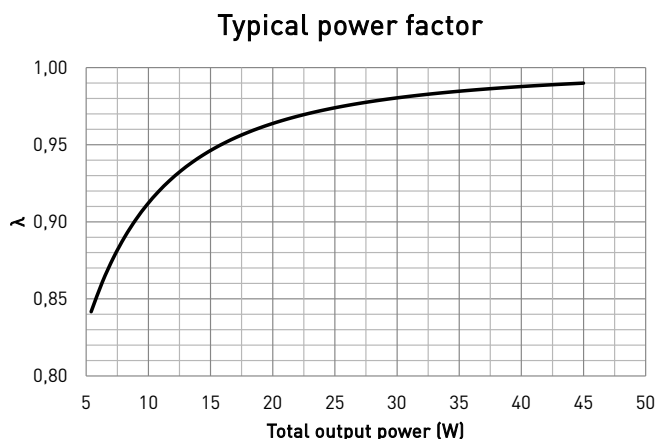
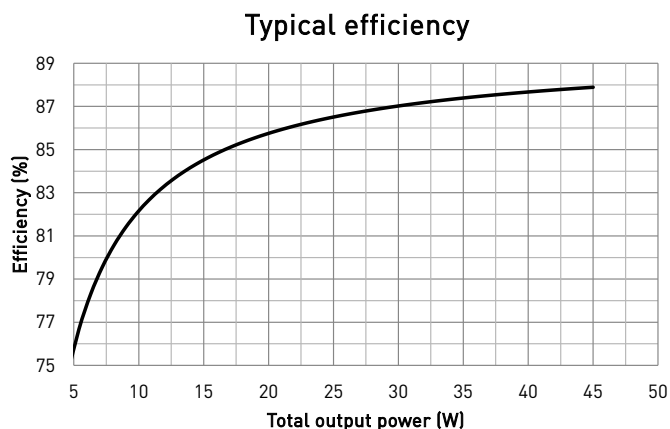
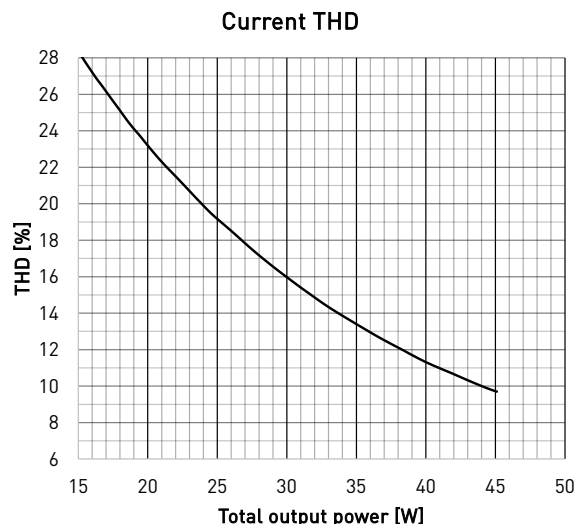
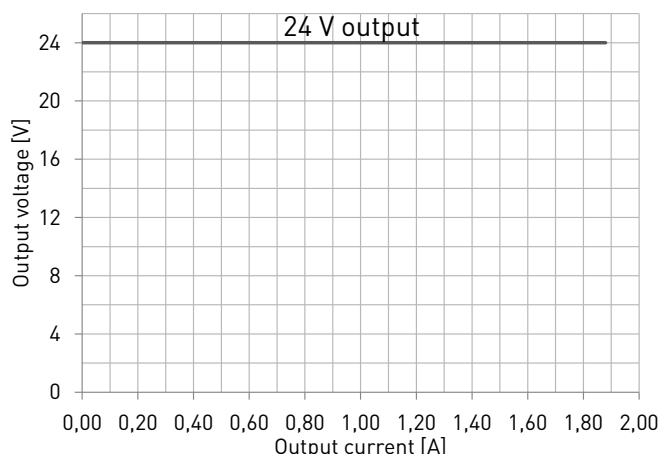

Operating Conditions and Characteristics

Max. temperature at tc point	85 °C
Tc life (50 000 h) temperature	80 °C
Ambient max. temperature range	-20...+50 °C
Storage temperature range	-40...+80 °C
Maximum relative humidity	No condensation

Lifetime table (90 % survival rate)

Output voltage	Ta	45 °C	50 °C
24 V	Tc at full load	80 °C	85 °C
	Lifetime	50 000 h	30 000 h

The shown Tc temperatures for each Ta environment in the table above are for guidance only, as the real relation between Ta and Tc depends always on the installation environment.

Never exceed the Tc maximum of the driver stated in the datasheet!

Connections and Mechanical Data

Wire size	0.5 - 1.5 mm ²
Wire type	Solid-core and fine-stranded
Wire insulation	According to EN 60598
Maximum driver to LED wire length	1.5 m
Weight	290 g
IP rating	IP20

Quantity of drivers per miniature circuit breaker 16 A Type C

Based on inrush current I_{peak}	Typ. peak inrush current I_{peak}	1/2 value time, Δt
24 pcs.	40 A	250 μs

CONVERSION TABLE FOR OTHER TYPES OF MINIATURE CIRCUIT BREAKER

MCB type	Relative quantity of LED drivers
B 10 A	37 %
B 16 A	60 %
B 20 A	75 %
C 10 A	62 %
C 16 A	100 % (see table above)
C 20 A	125 %

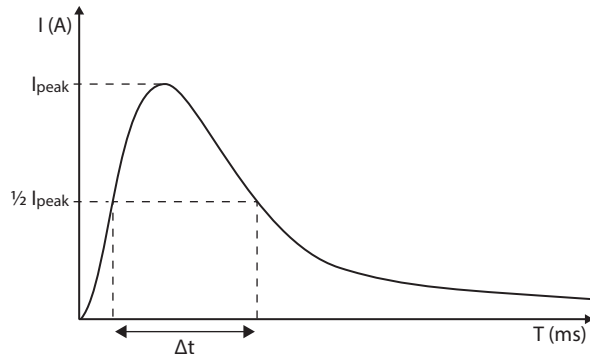

CONTINUOUS CURRENT

Total continuous current of the drivers and installation environment must always be considered and taken into calculations when installing drivers behind miniature circuit breaker. Example calculation of total drivers amount limited by continuous current: $n(I_{cont}) = (16 A (I_{nom,TC}) / \text{"nominal mains current with full load"}) \times 0.76$. This calculation is an example according to recommended precautions due to multiple adjacent circuit breakers (> 9 MCBs) and installation environment (T_a 30 degrees); variables may vary according to the use case. Both inrush current and continuous current calculations are based on ABB S200 series circuit breakers. More specific information in ABB series S200 circuit breaker documentation.

NOTE! Type C MCB's are strongly recommended to use with LED lighting. Please see more details in "MCB information" document in each driver product page in "downloads & links" section.

Connections

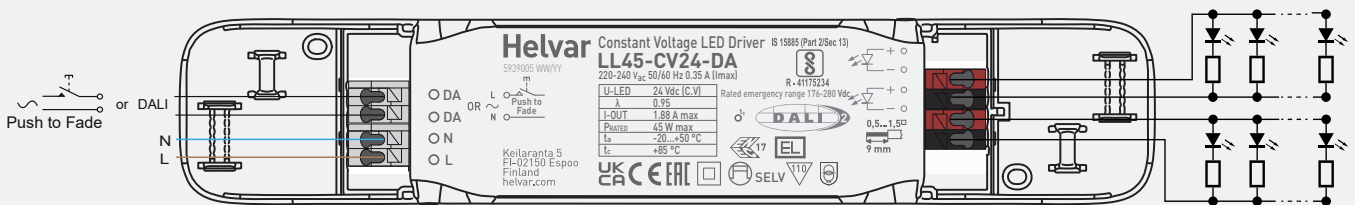

Note: Avoid using longer LED strips that 5 meters, the voltage losses grow substantial with long runs. In case of uneven brightness of LEDs in long strips, parallel connection of shorter strips is recommended.

Dimensions

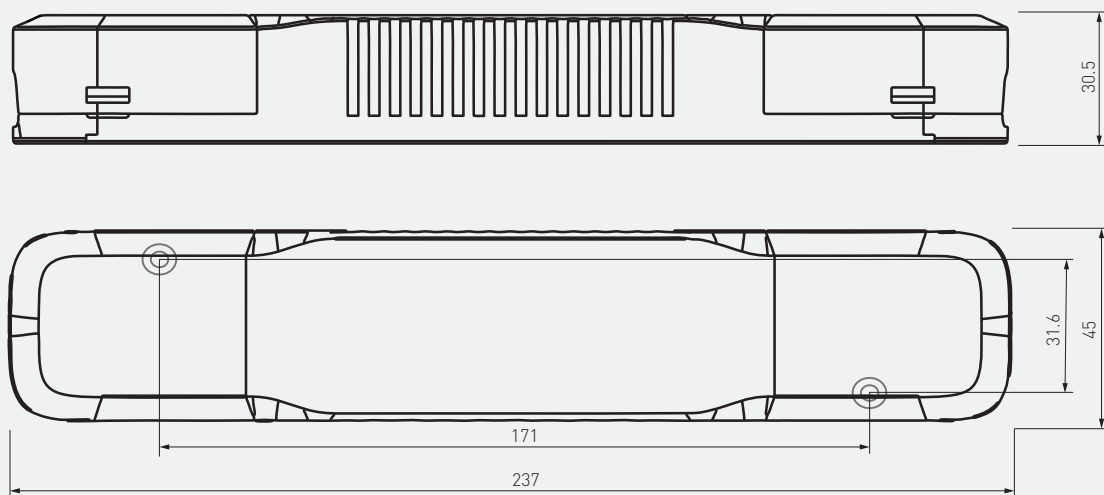

LL45-CV24-DA LED driver is suited for built-in and independent luminaire usage. In order to have safe and reliable LED driver operation, the LED luminaires will need to comply with the relevant standards and regulations (e.g. IEC/EN 60598-1). The LED luminaire shall be designed to adequately protect the LED driver from dust, moisture and pollution. The luminaire manufacturer is responsible for the correct choice and installation of the LED drivers according to the application and product datasheets. Operating conditions of the LED drivers may never exceed the specifications as per the product datasheet.

Installation & operation

Maximum t_c temperature:

- For built-in components inside luminaires, the t_a ambient temperature range is a guideline given for the optimum operating environment. However, integrator must always ensure proper thermal management (i.e. mounting base of the driver, air flow etc.) so that the t_c point temperature does not exceed the t_c maximum limit in any circumstance.
- Reliable operation and lifetime is only guaranteed if the maximum t_c point temperature is not exceeded under the conditions of use.

Installation site:

- The general preferred installation position of LED drivers for independent use is to have the top cover facing upwards
- In order to prevent condensation, relative humidity shall be low enough in relation to the ambient temperature

Miniature Circuit Breakers (MCB)

- Type-C MCB's with trip characteristics in according to EN 60898 are recommended.
- Please see more details in "MCB information" document in each driver product page in "downloads & links" section.

Dimming technology

- Dimming is implemented in PWM technology with very high frequency of 4 kHz.

Abnormal situation functionality

No load

When open load is detected, driver limits output voltage according to U_{out} (max) voltage.

Overload

The driver can withstand output overload.

Short circuit

When short circuit is detected, driver will go to standby mode. It will return to normal operation through mains reset.

AC to DC emergency lighting mode

When AC supply is switched to DC, driver will recognise this and switch to emergency lighting mode. The light level will be adjusted to 15 % of the nominal AC operation output. The DC light level cannot be adjusted or turned off by manual control or by active features. When the AC is switched back on, the driver returns to normal operation.

Push to Fade

Push to Fade is a simple-to-use lighting intensity control solution for optimal visual comfort. It includes additional fading behavior, which provides smooth transition between on and off states. Please note that Push to Fade is thus not compatible to be installed in the same circuit with Helvar Switch-Control or Switch-Control 2 devices.

Before installation and for troubleshoot and guidance, refer to the user guide at www.helvarcomponents.com.

Use of Push to Fade functionality

- Maximum numbers of LED drivers to be connected to one switch is 30.
- Ensure that all components connected to Push to Fade circuitry are mains rated.
- The transition time between 0 to 100% (when turned ON / OFF) is ~ 1 second.

Conformity & standards

General and safety requirements	EN 61347-1
Particular safety requirements for DC or AC supplied electronic control gear for LED modules	EN 61347-2-13
Additional safety requirements for AC or DC supplied electronic controlgear for emergency lighting	EN 61347-2-13, Annex J
Mains current harmonics	EN 61000-3-2
Limits for voltage fluctuations and flicker	EN 61000-3-3
Radio frequency interference	EN 55015
Immunity standard	EN 61547
Performance requirements	EN 62384
Digital addressing lighting interface:	
General requirements for DALI system	EN 62386-101 (DALI-2)
Requirements for DALI control gear	EN 62386-102 (DALI-2)
Requirements for control gear of LED modules (DALI Device Type 6)	EN 62386-207 (DALI-2)
Recommended Practices for Modulating Current in High-Brightness LEDs for Mitigating Health Risks to Viewers	IEEE 1789-2015
Compliant with relevant EU directives	
RoHS / REACH compliant	
ENEC & CE / UKCA marked	

Label symbols



Safety isolating control gear with short circuit protection (SELV control gear).



Double insulated control gear suitable for independent use.



Symbol for independent control gear.



AC/DC supplied electronic control gear for emergency lighting purposes intended for connection to a centralized emergency power supply.