

## 1. Lock the driver in the bottom part.

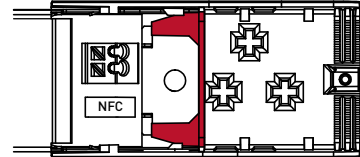

Ensure that the part marked with red colour is on top of the metal bottom part of the driver.

## 2. Connect wires according to driver datasheet.

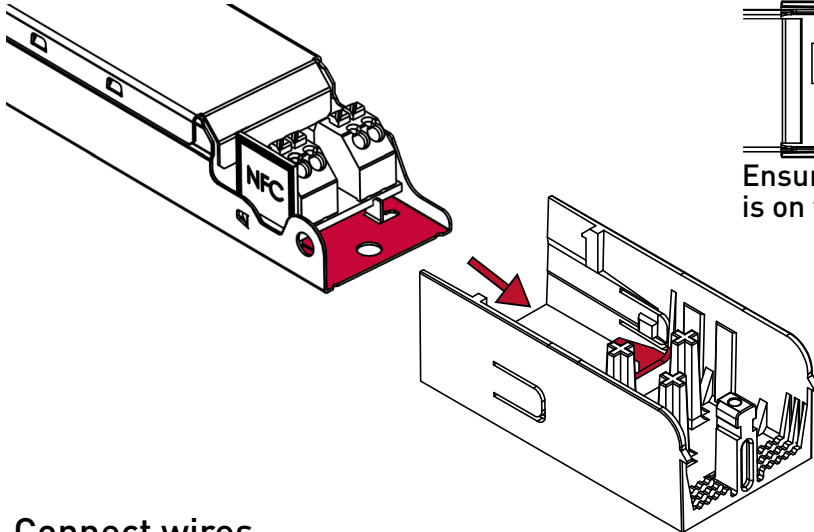
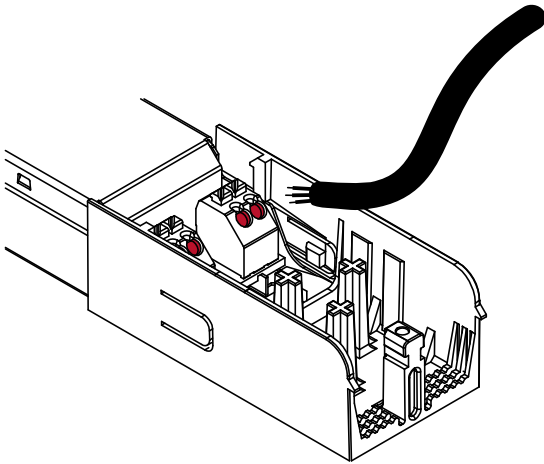

## 3. Examples for cable mounting into strain relief:

H03VV-F 2X0,75 mm<sup>2</sup>

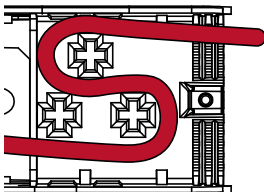

MMJ 5x1.5 mm<sup>2</sup>

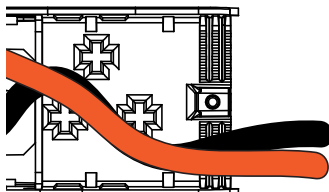

Up to 11mm

H05VV-F 3x1,0 mm<sup>2</sup>  
MMJ 3x1,5 mm<sup>2</sup>

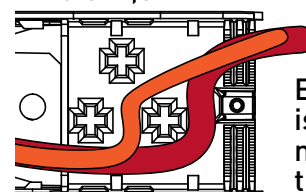

Up to 9mm

Ensure that the cable is firmly and securely mounted into the strain relief!

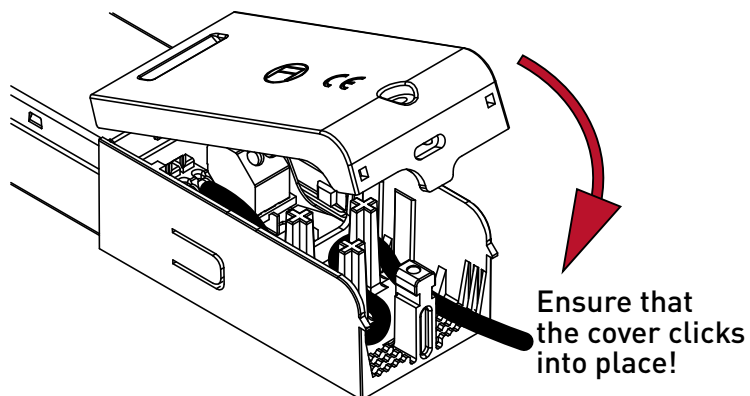
**4. Lock the cover on the bottom part.****5. Optional when needed.**  
(Screws supplied in the strain relief package)