

35 W SELV Dimmable DALI-2 LED driver

Product code: 5749

35 W 220 – 240 V 0/ 50 – 60 Hz

- DALI-2 certified LED driver, 1-100 % dimming range
- SELV output protection for safety and flexibility in luminaires
- Amplitude dimming for the highest quality light output
- NFC technology for wireless programming
- Low current ripple, complying with IEEE 1789 recommendation
- Suitable for DC use
- Optimised driver mechanics for independent usage applications
- Integrated spacious strain reliefs with screwless clamps, quick and simple installation process
- Doubled input terminals for looping the mains and DALI cables
- Ideal solution for Class I, Class II and Class III (SELV) luminaires



Functional Description

- Adjustable constant current output: 350 mA (default) to 850 mA
 - Current setting programmable via NFC, DALI or with external (LED-Iset) resistors
 - Suitable for flicker-free camera recording applications
 - Latest technology Switch-Control 2 functionality for easy-to-use intensity control
 - Innovative Direct Control technology to support easy luminaire-based personal lighting level control*
 - Full load recognition with automatic recovery, open and short circuit protection
 - Multipurpose terminal LED-Iset/NTC for current setting or overtemperature protection
 - Constant Light Output (CLO), adjustable up to 100 000 h (default disabled)
- *Available since revision C

Mains Characteristics

Voltage range	198 VAC – 264 VAC
DC range	Withstands max. 320 VAC (max. 1 hour)
starting voltage	176 VDC - 280 VDC
Mains current at full load	> 190 VDC
Frequency	0.10 – 0.21 A
Stand-by power consumption	0 / 50 Hz – 60 Hz
THD at full power	< 0.5 W
Leakage current to earth	< 12 %
Tested surge protection	< 0.3 mA
Tested fast transient protection	1 kV L-N, 2 kV L-GND (IEC 61000-4-5)
	2 kV (IEC 61000-4-4)

Insulation between circuits & driver case

Mains circuit - SELV circuit	Double/reinforced insulation
DALI circuit - SELV circuit	Double/reinforced insulation
Mains circuit - DALI circuit	Basic insulation
Mains, DALI and output - Driver case	Double/reinforced insulation
Mains input - Ground input	Basic insulation

Load Output (SELV <60 V)

Output current (I_{out})	350 mA (default) – 850 mA	
Accuracy	± 5 %	
Ripple	< 1 %* at ≤ 120 Hz	*] Low frequency, LED load: Cree XP-G LEDs
PstLM	< 0.03*	
SVM	< 0.01*	*] At full power, measured with Cree XP-G LED modules.
U_{out} (max) (abnormal)	60 V	

	350 mA	850 mA
I_{LED}	350 mA	850 mA
P_{Rated}	18.9 W	35.7 W
U_{LED}	25 - 54 V	25 - 42 V
PF (λ) at full load	0.93	0.96
Efficiency (η) at full load	85 %	88 %

Operating window

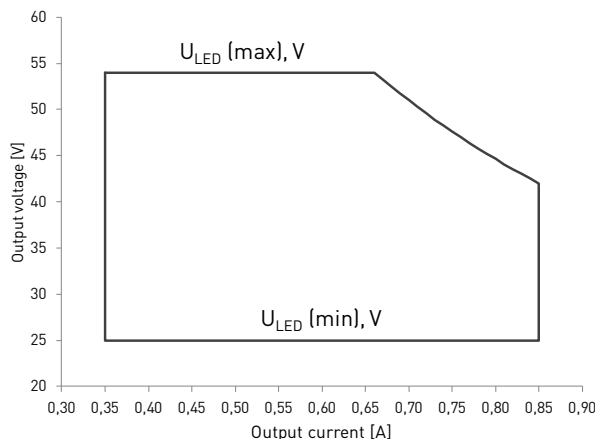

Note: Dimming between 1 % - 100 % possible across the whole operating window

Driver performance

Typical efficiency

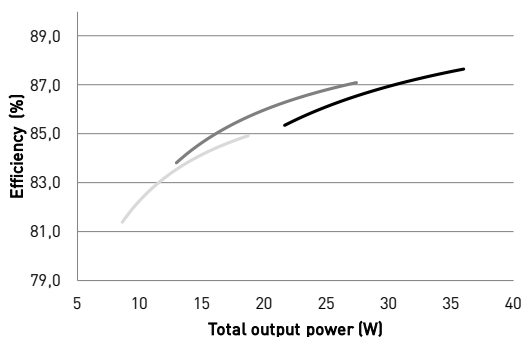

Typical power factor

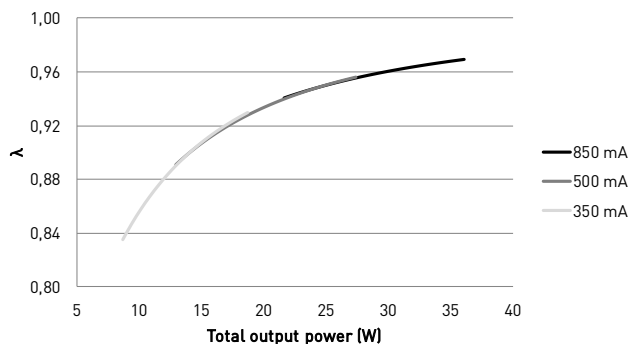

Operating Conditions and Characteristics

Absolute highest allowed t_c point temperature	80 °C
T_c life (60 000 h) temperature	80 °C
Ambient temperature range in independent use	-25 °C ... +50 °C*
Storage temperature range	-25 °C ... +50 °C
Maximum relative humidity	-40 °C ... +80 °C
Life time (90 % survival rate)	No condensation
	100 000 h, at $t_c = 70$ °C
	90 000 h, at $t_c = 75$ °C
	60 000 h, at $t_c = 80$ °C

*) For other than independent use, higher t_a of the controlgear possible as long as highest allowed t_c point temperature is not exceeded

Quantity of drivers per miniature circuit breaker 16 A Type C

Based on inrush current I_{peak}	Typ. peak inrush current I_{peak}	1/2 value time, Δt	Calculated energy, $I_{peak}^2 \Delta t$
111 pcs.	19 A	115 μ s	0.0313 A ² s

CONVERSION TABLE FOR OTHER TYPES OF MINIATURE CIRCUIT BREAKER

MCB type	Relative quantity of LED drivers
B 10 A	37 %
B 16 A	60 %
B 20 A	75 %
C 10 A	62 %
C 16 A	100 % [see table above]
C 20 A	125 %

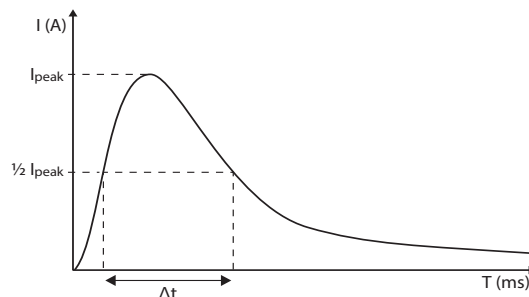

CONTINUOUS CURRENT

Total continuous current of the drivers and installation environment must always be considered and taken into calculations when installing drivers behind miniature circuit breaker. Example calculation of total drivers amount limited by continuous current: $n(I_{cont}) = [16 A (I_{nom, T_a}) / \text{"nominal mains current with full load"}] \times 0.76$. This calculation is an example according to recommended precautions due to multiple adjacent circuit breakers (> 9 MCBs) and installation environment (T_a 30 degrees); variables may vary according to the use case. Both inrush current and continuous current calculations are based on ABB S200 series circuit breakers. More specific information in ABB series S200 circuit breaker documentation.

NOTE! Type C MCB's are strongly recommended to use with LED lighting. Please see more details in "MCB information" document in each driver product page in "downloads & links" section.

Amplitude dimming technology

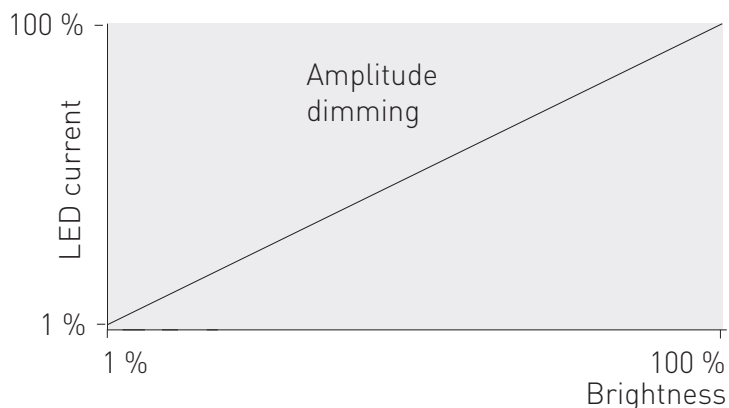

Dimming range	Dimming technology
1 % – 100 %	Amplitude (DC)

LC35SE-DA-350-850-LOOP LED driver implements amplitude dimming technology across whole dimming range. Amplitude dimming offers the best available technology for dimming the light output in an accurate and flicker-free way to ensure high quality lighting in even the most demanding situations such as camera recording applications. Amplitude dimming technology complies with IEEE 1789-2015 recommendations of current modulation to mitigate health risks to viewers.

Wireless configuration

LC35SE-DA-350-850-LOOP LED driver is equipped with NFC wireless technology for effortless configuration of the driver via Helvar Driver Configurator Support. Helvar Driver Configurator enables easy-to-use automatic configuration of the driver parameters via NFC, without mains or DALI connection to the driver. The most popular MD-SIG qualified NFC readers (FEIG CPR30-USB & ISC.MR102-USB) are supported giving flexibility for the operator. For further information about the usage with Helvar Driver Configurator, please see the user guide at www.helvarcomponents.com

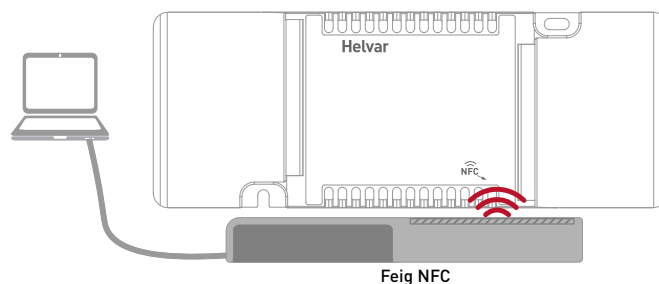

Direct Control

LC35SE-DA-350-850-LOOP LED driver supports innovative Direct Control functionality, enabled in Helvar Driver Configurator. With Direct Control enabled (disabled as default), the user is able to control the light level via Iset / LED-Iset terminal with single switch (push to make), such as pull cord mechanism or local push button. This gives the unique possibility to implement luminaire-based control in the most simple manner. Direct Control follows the same operation logic as Switch-Control (more details on page 6).

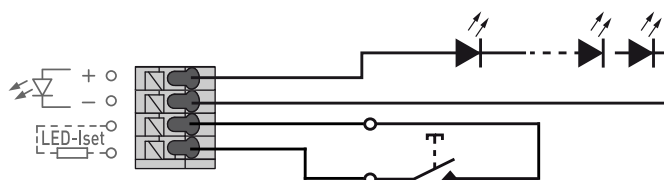

Connections and Mechanical Data

Wire size	Input: 0.5 mm ² – 2.5 mm ²
Wire type	Output: 0.5 mm ² – 1.5 mm ²
Wire insulation	Solid core and fine-stranded
Maximum current through looping terminals	According to EN 60598
Maximum driver to LED wire length	16 A
Weight	1.5 m
IP rating	209 g
	IP20

Connections

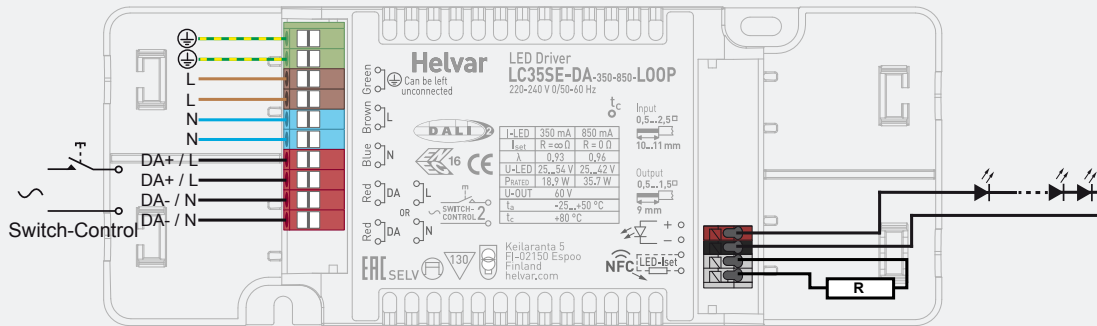

Note:

- PE terminal is for looping only and therefore earth connection is not needed for the functionality of the driver. See page 4 for details.
- When looping mains, only additional LED drivers shall be connected through the device terminals
- Not suitable for load side switching operation
- Label may differ if the unit is preset to fixed current

Dimensions (mm)

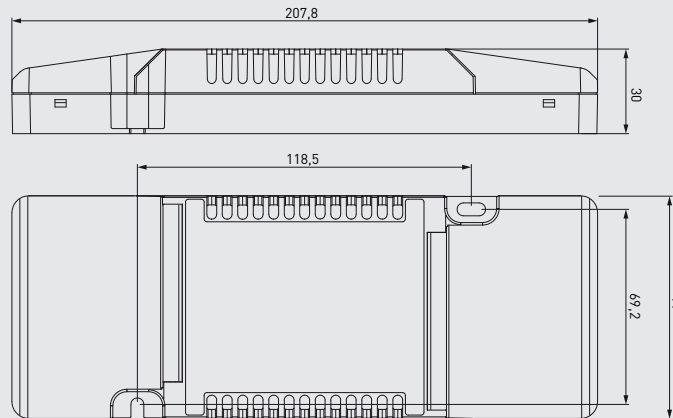

The LED-Iset resistor/current setting values are adjusted according to the LEDset specification. The resistor value for each required output current can thus be calculated from the formula $R [\Omega] = (5 [V] / I_{out} [A]) * 1000$. Below are the available LED-Iset resistors from Helvar Components, pre-adjusted for the most common output currents.

Helvar Components LED-Iset resistors and currents (Nominal $I_{out} (\pm 5\% \text{ tol.})$)

LED-Iset resistor model	MAX	800 mA	750 mA	700 mA	650 mA	600 mA	550 mA	500 mA	475 mA	450 mA	425 mA	400 mA	375 mA	No resistor
I_{out} (mA)	850	800	750	700	650	600	550	500	475	450	425	400	375	350
Order code	T90000	T90800	T90750	T90700	T90650	T90600	T90550	T90500	T90475	T90450	T90425	T90400	T90350	N/A
Resistance values (Ω)	0	6.2k	6.65k	7.15k	7.68k	8.25k	9.09k	10k	10.5k	11k	11.8k	12.4k	13.3k	∞

The current can be adjusted also with normal resistors by selecting suitable resistor value (formula $R [\Omega] = (5 [V] / I_{out} [A]) * 1000$). Reference resistor values can be found below order code in the table above.

LC35SE-DA-350-850-LOOP LED driver is suited for independent use and built-in usage in luminaires. In order to have safe and reliable LED driver operation, the LED luminaires will need to comply with the relevant standards and regulations (e.g. IEC/EN 60598-1). The LED luminaire shall be designed to adequately protect the LED driver from dust, moisture and pollution. The luminaire manufacturer is responsible for the correct choice and installation of the LED drivers according to the application and product datasheets. Operating conditions of the LED drivers may never exceed the specifications as per the product datasheet.

Installation & operation

Maximum ambient and t_c temperature:

- For built-in components inside luminaires, the t_a ambient temperature range is a guideline given for the optimum operating environment. However, integrator must always ensure proper thermal management (i.e. mounting base of the driver, air flow etc.) so that the t_c point temperature does not exceed the t_c maximum limit in any circumstance.
- Reliable operation and lifetime is only guaranteed if the maximum t_c point temperature is not exceeded under the conditions of use.

Current setting resistor

LC35SE-DA-350-850-LOOP LED driver features a constant current output adjustable via current setting resistor.

- An external resistor can be inserted in to the current setting terminal, allowing the user to adjust the LED driver output current.
- When no external resistor is connected, then the LED drivers will operate at their default lowest current level.
- A standard through-hole resistor can be used for the current setting. To achieve the most accurate output current it is recommended to select a quality low tolerance resistor. Minimum diameter for resistor leg is 0.51mm.
- Always connect the current setting resistor only into the terminals marked with LED-Iset on the LED driver label.
- For the resistor/current values, refer to the table on page 3.

LED driver earthing

- LC35SE-DA-350-850-LOOP is Class I LED driver suitable for Class I and II luminaires, as well as driving Class III (SELV) luminaire parts in independent installation.
- If used inside **Class I** luminaires, the earth cable is not required for electrical safety in this driver. The PE connection is designed for earth signal looping between drivers.
- If used inside **Class II** luminaires, the safety of the luminaire shall be ensured through double/reinforced insulation of live parts. LC35SE-DA-350-850-LOOP has double/reinforced insulation between accessible and live parts, and is suitable for use in all Class II luminaires. In this case the earth terminal of the driver must be left unconnected and the luminaire terminal block shall not have any protective earthing terminal.
- If used in **independent** installation with Class I/II/III luminaires, the earth cable is not required to be connected. The PE connection is designed for earth signal looping between drivers.

Miniature Circuit Breakers (MCB)

- Type-C MCB's with trip characteristics in according to EN 60898 are recommended.
- Please see more details in "MCB information" document in each driver product page in "downloads & links" section.

Installation site

- The general preferred installation position of LED drivers for independent use is to have the top cover facing upwards.
- Minimum recommended distances below:

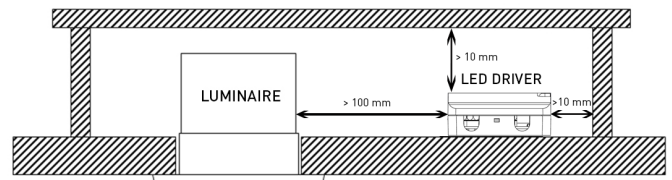

- Suitable for installation upside down and in the corner, in this case separate spacers must be used. For more information, please consult Helvar Components.

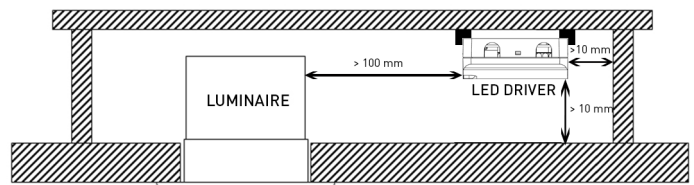

Helvar Driver Configurator -support

LC35SE-DA-350-850-LOOP LED driver is supported by Helvar Driver configurator software. The LC35SE-DA-350-850-LOOP driver supports output current setting with software, the output current of the driver can be programmed using Helvar Driver Configurator, as well as OEM customer data and parameters for functions such as CLO. Programming the driver with Helvar Driver Configurator can be done either wirelessly via NFC or then via DALI bus. Also the operation of the multifunction LED-Iset terminal usage can be changed from current setting resistor (default) to NTC overtemperature protection operation or to Direct Control functionality.

Lamp failure functionality

No load

When open load is detected, driver will go to standby power consumption and remains in automatic recovery mode. In automatic recovery mode, the driver waits till load is returned and once that happens, it returns to normal operation.

Short circuit

When short circuit is detected, driver goes to automatic recovery mode and follows the same logic as described in the no load condition.

Overload

When overload is detected, driver goes to standby mode and returns through mains reset.

Underload

When undervoltage is detected, driver goes to standby mode and returns through mains reset.

NTC trigger

When NTC is enabled via Helvar Driver Configurator, driver follows NTC feature behaviour. Default NTC trigger point is 8,2 kΩ, after which the driver starts to decrease the output level.

Switch-Control 2 & Direct Control

Before installation and for troubleshoot and guidance, refer to Switch-Control & Direct Control User Guide at www.helvarcomponents.com.

Use of Switch-Control functionality

- Maximum numbers of LED drivers to be connected to one switch is 60. Wire length is not restricted by the driver technology.
- Ensure that all components connected to Switch-Control circuitry are mains rated.
- The X2 rated (1 μF) capacitor has to be installed between control lines incase of unwanted behavior of lights. See details and guidance from the user guide.

Use of Direct Control functionality

- Maximum one LED driver shall be connected to single switch through Direct Control.
- Maximum wire length between driver and the switch is 10 m.
- By default, Direct Control is disabled and LED-Iset terminal is used for current setting. When enabled through the Helvar Driver Configurator, the current is set by the software.
- With SELV60 drivers the Direct Control circuit is SELV60 circuit. The components can be rated accordingly.
- DALI usage not supported at the same time with Direct Control.

Conformity & standards

General and safety requirements	EN 61347-1
Particular safety requirements for DC or AC supplied electronic control gear for LED modules	EN 61347-2-13
Thermal protection class	EN 61347, C5e
Mains current harmonics	EN 61000-3-2
Limits for voltage fluctuations and flicker	EN 61000-3-3
Radio frequency interference	EN 55015
Immunity standard	EN 61547
Performance requirements	EN 62384
Digital addressing lighting interface:	
General requirements for DALI system	EN 62386-101 (DALI-2)
Requirements for DALI control gear	EN 62386-102 (DALI-2)
Requirements for control gear of LED modules (DALI Device Type 6)	EN 62386-207 (DALI-2)
Recommended Practices for Modulating Current in High-Brightness LEDs for Mitigating Health Risks to Viewers	IEEE 1789-2015
Compliant with relevant EU directives	
RoHS/REACH compliant	
ENEC and CE / UKCA marked	

Label symbols



Safety isolating control gear with short circuit protection (SELV control gear).



Thermally controlled control gear, incorporating means of protection against overheating to prevent the case temperature under any conditions of use from exceeding 130 °C.



DALI-2 certified control gear.



Driver equipped with NFC wireless technology for effortless configuration.